

**ИМПЛАНТАЦИОННАЯ СИСТЕМА SEWON MEDIX**  

---

**КАТАЛОГ ПРОДУКЦИИ**



# IH SYSTEM

## PRODUCT CATALOG

# Contents

## IH SYSTEM

---

IH2 SLA Fixture	5
Cover Screw / Mount	8
Healing Abutment	9

## Prosthetic Flow Diagram 1

---

Cement Abutment	13
Angled Abutment	23
FreeMilling Abutment	30
CCM Casting Abutment	37
Temporary Abutment	39
Fixture Level Impression Coping / Analog	42

## Prosthetic Flow Diagram 2

---

Multi-unit Abutment	53
Multi-unit Abutment Components	57

## Prosthetic Flow Diagram 3

---

LT Abutment	62
BT Abutment	66

## Etc.

---

Ti-Custom Block	70
Ti-Base Abutment	74

## Instruments

---

Surgical Kit	76
Prosthetic kit	89

---

# ИМПЛАНТАЦИОННАЯ СИСТЕМА SEWON MEDIX



## Импантаты IH2 SLA

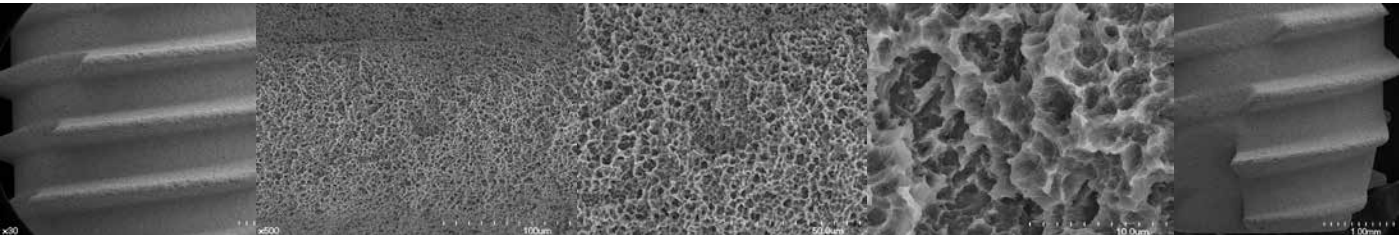

### Feature of IH2 SLA Fixture

- Internal hex & 11° morse taper connected, submerged fixture
- SLA surface morphology and roughness increased by 45% compared to RBM treatment.
- SLA : Sandblasting with Large grits and Acid etching
  - Optimal surface roughness : Ra 2.5~3.0/μm
- Taper body offers high initial stability
- Powerful Self threading
- Limited insertion torque : 40Ncm

We recommend that the fixture with over 4.5mm diameter is used for single case in molar.

# IH2 SLA Fixture

FIXTURE

## Mini Ø3.5

2.1

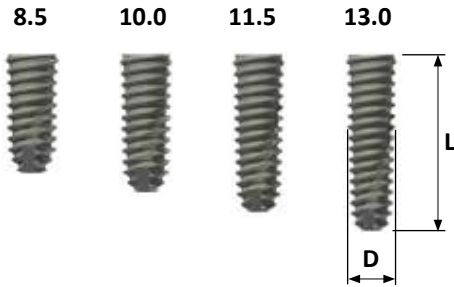

L \ D	Mini Ø3.5
8.5	IH2FM3508S
10.0	IH2FM3510S
11.5	IH2FM3511S
13.0	IH2FM3513S

## Regular Ø3.5

2.5

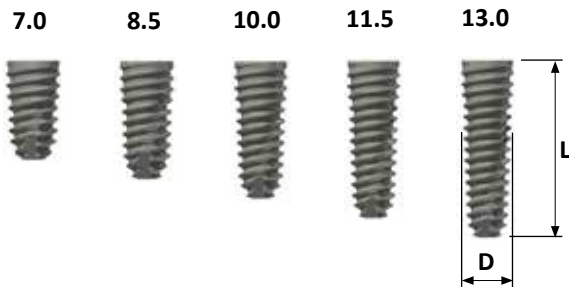

L \ D	Regular Ø3.5
7.0	IH2FR3507S
8.5	IH2FR3508S
10.0	IH2FR3510S
11.5	IH2FR3511S
13.0	IH2FR3513S

## Regular Ø4.0

2.5

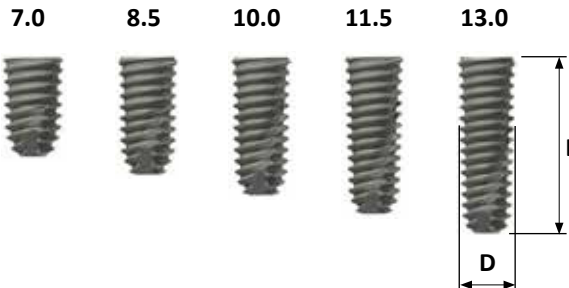

L \ D	Regular Ø4.0
7.0	IH2FR4007S
8.5	IH2FR4008S
10.0	IH2FR4010S
11.5	IH2FR4011S
13.0	IH2FR4013S

- No-Mount fixture (Fixture + Cover screw) order code : A+Product code (ex : AIH2FR3510S)
- Pre-Mounted fixture (Fixture + Mount + Cover screw) order code : B+Product code (ex : BIH2FR3510S)

# IH2 SLA Fixture

## Regular $\varnothing 4.5$

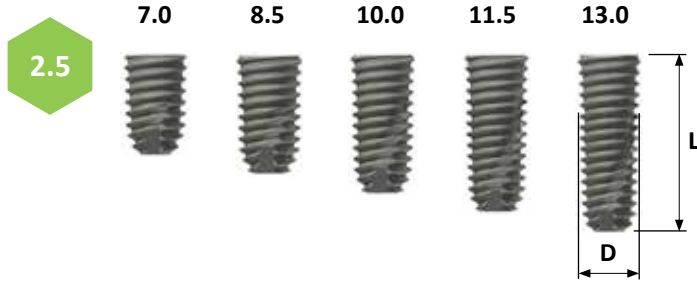

L \ D	Regular $\varnothing 4.5$
7.0	IH2FR4507S
8.5	IH2FR4508S
10.0	IH2FR4510S
11.5	IH2FR4511S
13.0	IH2FR4513S

## Regular $\varnothing 5.0$

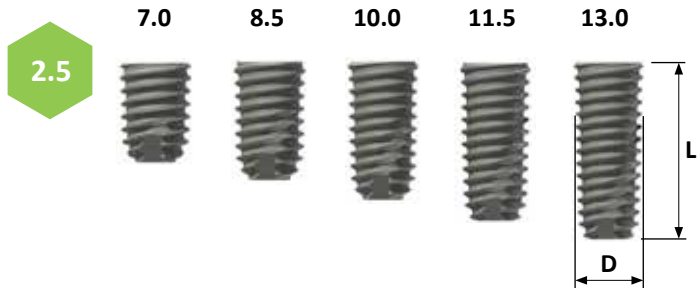

L \ D	Regular $\varnothing 5.0$
7.0	IH2FR5007S
8.5	IH2FR5008S
10.0	IH2FR5010S
11.5	IH2FR5011S
13.0	IH2FR5013S

## Regular $\varnothing 6.0$

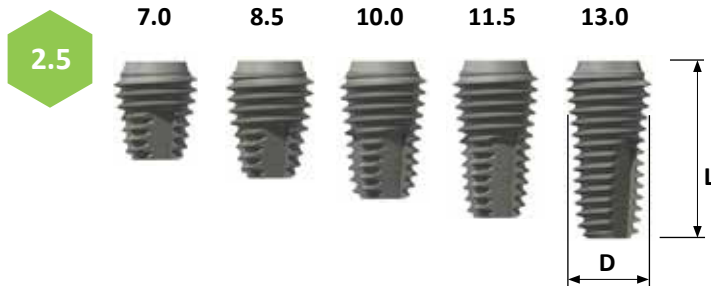

L \ D	Regular $\varnothing 6.0$
7.0	IH2FR6007S
8.5	IH2FR6008S
10.0	IH2FR6010S
11.5	IH2FR6011S
13.0	IH2FR6013S

- No-Mount fixture (Fixture + Cover screw) order code : A+Product code (ex : AIH2FR4510S)
- Pre-Mounted fixture (Fixture + Mount + Cover screw) order code : B+Product code (ex : BIH2FR4510S)

## Cover Screw

FIGURE



Fixture	Mini(Ø3.5)	Regular(Ø3.5)	Regular(Ø4.0~5.0)
Color	Purple	Blue	Green
Code	IHCSM	IHCSR32	IHCSR

- Tightening torque : 5~8Ncm
- Use the hex driver



## Mount



Fixture	Mini(Ø3.5)	Regular(Ø3.5)	Regular(Ø4.0~5.0)
Color	Yellow	Blue	Green
Code	IHFMM35	IHFMR37	IHFMR40

- Tightening torque : 8~10Ncm
- Use the hex driver
- Single-use





# Healing Abutment

## Mini Ø4.0

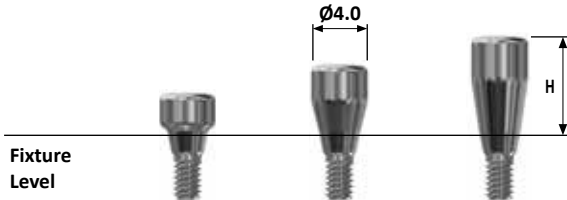

H \ D	Mini Ø4.0
3.0	IHHAM403
5.0	IHHAM405
7.0	IHHAM407

## Mini Ø4.5

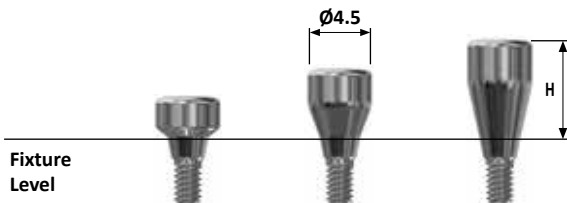

H \ D	Mini Ø4.5
3.0	IHHAM453
5.0	IHHAM455
7.0	IHHAM457

## Regular Ø4.0

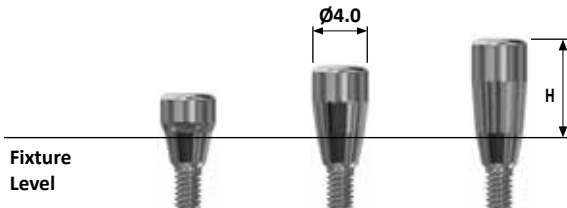

H \ D	Regular Ø4.0
3.0	IHHAR403
5.0	IHHAR405
7.0	IHHAR407

## Regular Ø4.5

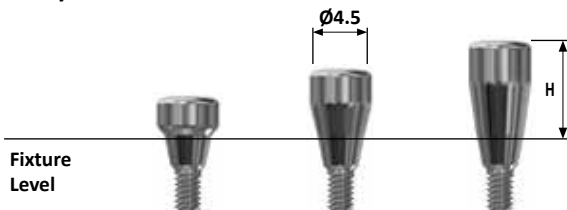

H \ D	Regular Ø4.5
3.0	IHHAR453
5.0	IHHAR455
7.0	IHHAR457

- Tightening torque : 5~8Ncm
- Use the hex driver

# Healing Abutment

HEALING

## Regular $\varnothing 5.0$

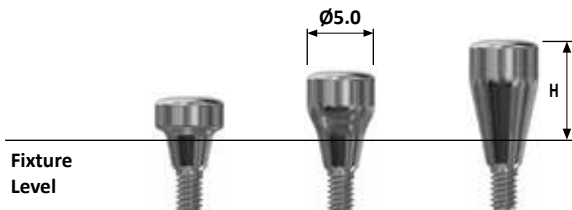

H \ D	Regular $\varnothing 5.0$
3.0	IHHAR503
5.0	IHHAR505
7.0	IHHAR507

## Regular $\varnothing 5.5$

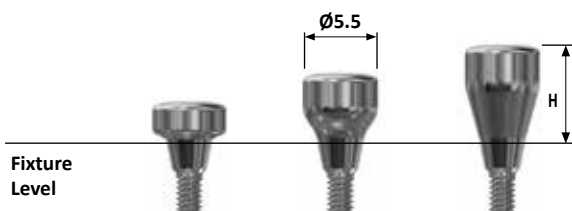

H \ D	Regular $\varnothing 5.5$
3.0	IHHAR553
5.0	IHHAR555
7.0	IHHAR557

## Regular $\varnothing 6.0$

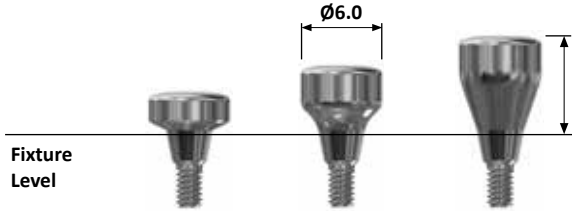

H \ D	Regular $\varnothing 6.0$
3.0	IHHAR603
5.0	IHHAR605
7.0	IHHAR607

## Regular $\varnothing 6.5$

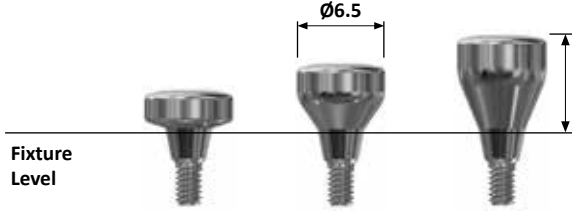

H \ D	Regular $\varnothing 6.5$
3.0	IHHAR653
5.0	IHHAR655
7.0	IHHAR657

- Tightening torque : 5~8Ncm
- Use the hex driver

# SEWON MEDIX IMPLANT SYSTEM



# Prosthetic Flow Diagram 1

## Cement Retained Restoration

Cement / Angled / FreeMilling / Temporary

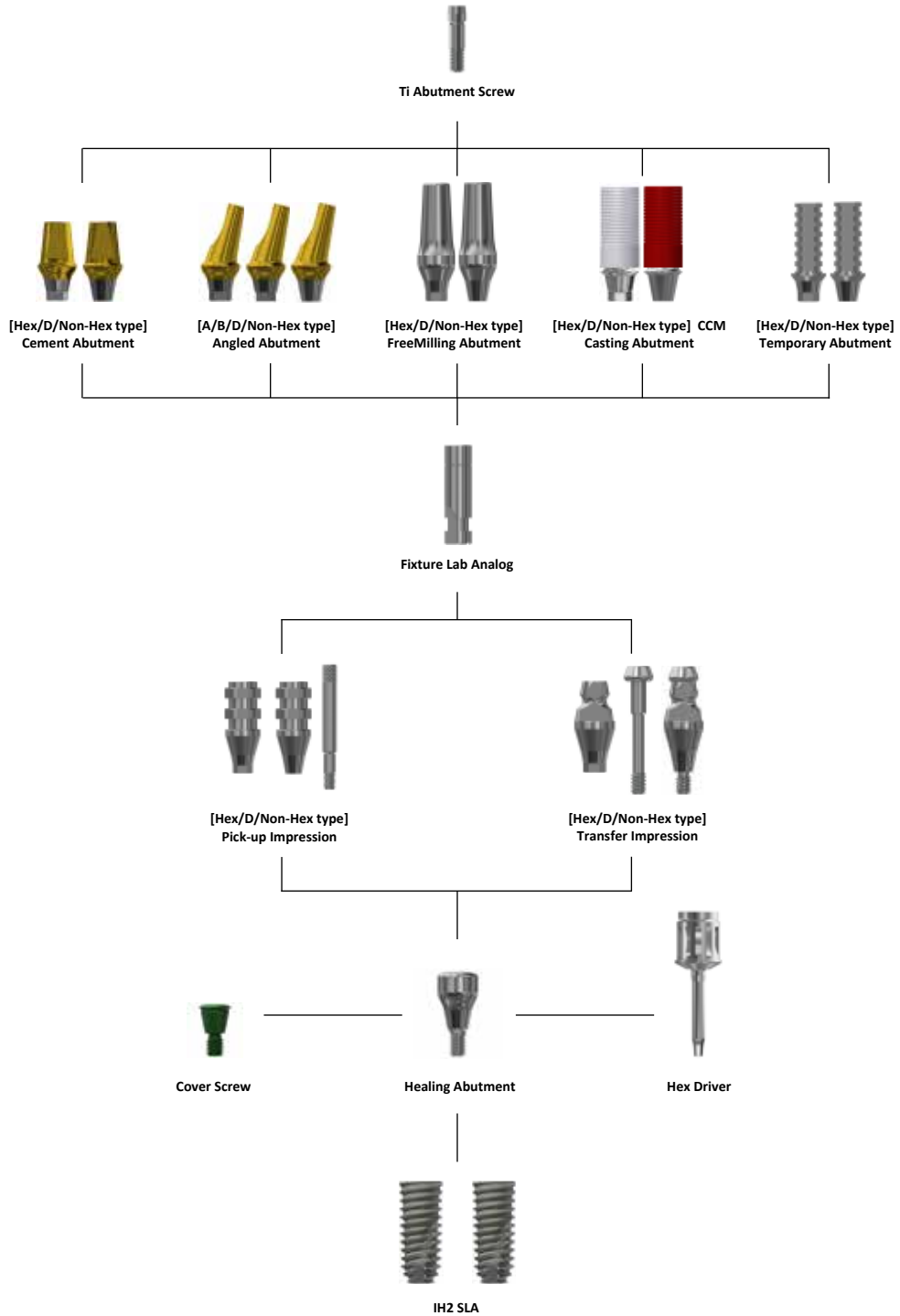

# Cement Abutment(HEX TYPE)

- Use for making general cement-type prosthesis
- 11°taper connection for excellent safety
- Cross-section design for the prevention of prosthesis rotation
- Packing unit : Abutment + Ti-screw

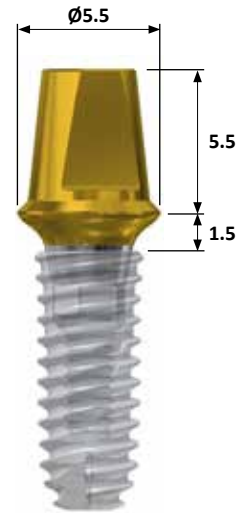

IHCARH5515M

CEMENT

S

D

N

## Mini Ø4.5

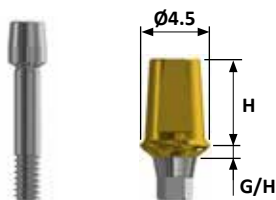

Mini Ø4.5		
H \ G/H	5.5	7.0
1.0	IHCAMH4510M	IHCAMH4510L
1.5	IHCAMH4515M	IHCAMH4515L
2.0	IHCAMH4520M	IHCAMH4520L
2.5	IHCAMH4525M	IHCAMH4525L
3.0	IHCAMH4530M	IHCAMH4530L
3.5	IHCAMH4535M	IHCAMH4535L
4.0	IHCAMH4540M	IHCAMH4540L

• Ti-Screw code : IHASM

- Abutment + Screw order code : A+Product code(ex : AIHCAMH4520MC)
- Tightening torque : 20Ncm      • Use the hex driver

# Cement Abutment(HEX TYPE)

## Regular $\varnothing 4.5$

CEMENT

S

D

N

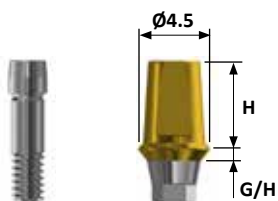

Regular $\varnothing 4.5$		
G/H \ H	5.5	7.0
1.0	IHCARH4510M	IHCARH4510L
1.5	IHCARH4515M	IHCARH4515L
2.0	IHCARH4520M	IHCARH4520L
2.5	IHCARH4525M	IHCARH4525L
3.0	IHCARH4530M	IHCARH4530L
3.5	IHCARH4535M	IHCARH4535L
4.0	IHCARH4540M	IHCARH4540L

• Ti-Screw code : IHASR

## Regular $\varnothing 5.0$

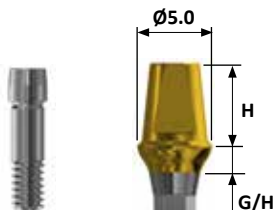

Regular $\varnothing 5.0$		
G/H \ H	5.5	7.0
1.0	IHCARH5010M	IHCARH5010L
1.5	IHCARH5015M	IHCARH5015L
2.0	IHCARH5020M	IHCARH5020L
2.5	IHCARH5025M	IHCARH5025L
3.0	IHCARH5030M	IHCARH5030L
3.5	IHCARH5035M	IHCARH5035L
4.0	IHCARH5040M	IHCARH5040L

• Ti-Screw code : IHASR

- Abutment + Screw order code : A+Product code(ex : AIHCARH5020MC)
- Tightening torque : 30Ncm
- Use the hex driver

# Cement Abutment(HEX TYPE)

## Regular $\varnothing 5.5$

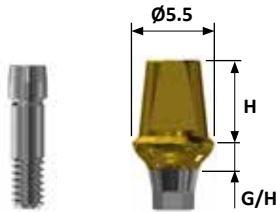

Regular $\varnothing 5.5$		
G/H \ H	5.5	7.0
1.0	IHCARH5510M	IHCARH5510L
1.5	IHCARH5515M	IHCARH5515L
2.0	IHCARH5520M	IHCARH5520L
2.5	IHCARH5525M	IHCARH5525L
3.0	IHCARH5530M	IHCARH5530L
3.5	IHCARH5535M	IHCARH5535L
4.0	IHCARH5540M	IHCARH5540L

• Ti-Screw code : IHASR

## Regular $\varnothing 6.0$

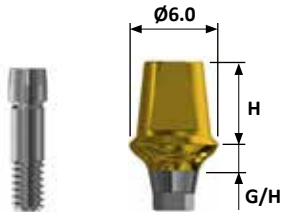

Regular $\varnothing 6.0$		
G/H \ H	5.5	7.0
1.0	IHCARH6010M	IHCARH6010L
1.5	IHCARH6015M	IHCARH6015L
2.0	IHCARH6020M	IHCARH6020L
2.5	IHCARH6025M	IHCARH6025L
3.0	IHCARH6030M	IHCARH6030L
3.5	IHCARH6035M	IHCARH6035L
4.0	IHCARH6040M	IHCARH6040L

• Ti-Screw code : IHASR

- Abutment + Screw order code : A+Product code(ex : AIHCARH5520MC)
- Tightening torque : 30Ncm      • Use the hex driver

# Cement Abutment(HEX TYPE)

Regular  $\varnothing 6.5$



CEMENT

S

D

N

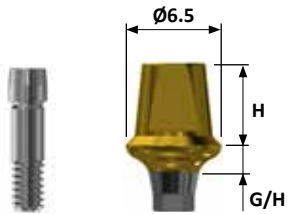

Regular $\varnothing 6.5$		
G/H \ H	5.5	7.0
1.0	IHCARH6510M	IHCARH6510L
1.5	IHCARH6515M	IHCARH6515L
2.0	IHCARH6520M	IHCARH6520L
2.5	IHCARH6525M	IHCARH6525L
3.0	IHCARH6530M	IHCARH6530L
3.5	IHCARH6535M	IHCARH6535L
4.0	IHCARH6540M	IHCARH6540L

• Ti-Screw code : IHASR

- Abutment + Screw order code : A+Product code(ex : AIHCARH6520MC)
- Tightening torque : 30Ncm
- Use the hex driver



# Cement Abutment(HEX D-TYPE)

## Regular $\phi 4.5$

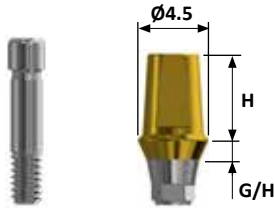

Regular $\phi 4.5$		
G/H \ H	5.5	7.0
1.0	IHCARH4510MD	IHCARH4510LD
1.5	IHCARH4515MD	IHCARH4515LD
2.0	IHCARH4520MD	IHCARH4520LD
2.5	IHCARH4525MD	IHCARH4525LD
3.0	IHCARH4530MD	IHCARH4530LD
3.5	IHCARH4535MD	IHCARH4535LD
4.0	IHCARH4540MD	IHCARH4540LD

• Ti-Screw code : IHASD128

## Regular $\phi 5.0$

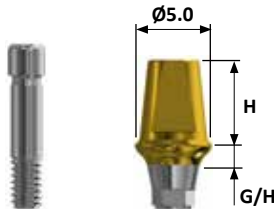

Regular $\phi 5.0$		
G/H \ H	5.5	7.0
1.0	IHCARH5010MD	IHCARH5010LD
1.5	IHCARH5015MD	IHCARH5015LD
2.0	IHCARH5020MD	IHCARH5020LD
2.5	IHCARH5025MD	IHCARH5025LD
3.0	IHCARH5030MD	IHCARH5030LD
3.5	IHCARH5035MD	IHCARH5035LD
4.0	IHCARH5040MD	IHCARH5040LD

• Ti-Screw code : IHASD128

- Abutment + Screw order code : A+Product code(ex : AIHCARH5020MD)
- Tightening torque : 30Ncm      • Use the hex driver

CEMENT  
S  
D  
N

# Cement Abutment(HEX D-TYPE)

## Regular Ø5.5

CEMENT

S  
D  
N

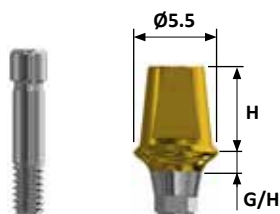

Regular Ø5.5		
G/H \ H	5.5	7.0
1.0	IHCARH5510MD	IHCARH5510LD
1.5	IHCARH5515MD	IHCARH5515LD
2.0	IHCARH5520MD	IHCARH5520LD
2.5	IHCARH5525MD	IHCARH5525LD
3.0	IHCARH5530MD	IHCARH5530LD
3.5	IHCARH5535MD	IHCARH5535LD
4.0	IHCARH5540MD	IHCARH5540LD

• Ti-Screw code : IHASD128

## Regular Ø6.0

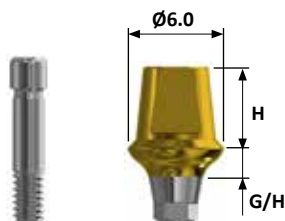

Regular Ø6.0		
G/H \ H	5.5	7.0
1.0	IHCARH6010MD	IHCARH6010LD
1.5	IHCARH6015MD	IHCARH6015LD
2.0	IHCARH6020MD	IHCARH6020LD
2.5	IHCARH6025MD	IHCARH6025LD
3.0	IHCARH6030MD	IHCARH6030LD
3.5	IHCARH6035MD	IHCARH6035LD
4.0	IHCARH6040MD	IHCARH6040LD

• Ti-Screw code : IHASD128

- Abutment + Screw order code : A+Product code(ex : AIHCARH5520MD)
- Tightening torque : 30Ncm
- Use the hex driver

# Cement Abutment(HEX D-TYPE)

Regular  $\varnothing 6.5$

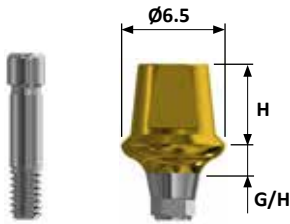

Regular $\varnothing 6.5$		
G/H \ H	5.5	7.0
1.0	IHCARH6510MD	IHCARH6510LD
1.5	IHCARH6515MD	IHCARH6515LD
2.0	IHCARH6520MD	IHCARH6520LD
2.5	IHCARH6525MD	IHCARH6525LD
3.0	IHCARH6530MD	IHCARH6530LD
3.5	IHCARH6535MD	IHCARH6535LD
4.0	IHCARH6540MD	IHCARH6540LD

• Ti-Screw code : IHASD128

CEMENT

S

D

N

- Abutment + Screw order code : A+Product code(ex : AIHCARH6520MD)
- Tightening torque : 30Ncm      • Use the hex driver

# Cement Abutment(NON-HEX TYPE)

## Mini Ø4.5

CEMENT

S  
D  
N

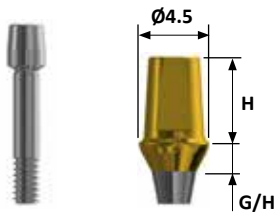

Mini Ø4.5		
H \ G/H	5.5	7.0
1.0	IHCAMN4510M	IHCAMN4510L
1.5	IHCAMN4515M	IHCAMN4515L
2.0	IHCAMN4520M	IHCAMN4520L
2.5	IHCAMN4525M	IHCAMN4525L
3.0	IHCAMN4530M	IHCAMN4530L
3.5	IHCAMN4535M	IHCAMN4535L
4.0	IHCAMN4540M	IHCAMN4540L

• Ti-Screw code : IHASM

## Regular Ø4.5

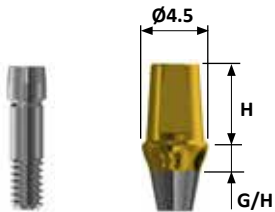

Regular Ø4.5		
H \ G/H	5.5	7.0
1.0	IHCARN4510M	IHCARN4510L
1.5	IHCARN4515M	IHCARN4515L
2.0	IHCARN4520M	IHCARN4520L
2.5	IHCARN4525M	IHCARN4525L
3.0	IHCARN4530M	IHCARN4530L
3.5	IHCARN4535M	IHCARN4535L
4.0	IHCARN4540M	IHCARN4540L

• Ti-Screw code : IHASR

- Abutment + Screw order code : A+Product code(ex : AIHCARN4520MC)
- Tightening torque : Mini-20Ncm, Regular-30Ncm
- Use the hex driver

# Cement Abutment(NON-HEX TYPE)

## Regular $\phi 5.0$

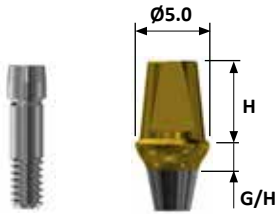

Regular $\phi 5.0$		
G/H \ H	5.5	7.0
1.0	IHCARN5010M	IHCARN5010L
1.5	IHCARN5015M	IHCARN5015L
2.0	IHCARN5020M	IHCARN5020L
2.5	IHCARN5025M	IHCARN5025L
3.0	IHCARN5030M	IHCARN5030L
3.5	IHCARN5035M	IHCARN5035L
4.0	IHCARN5040M	IHCARN5040L

• Ti-Screw code : IHASR

## Regular $\phi 5.5$

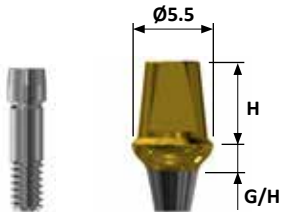

Regular $\phi 5.5$		
G/H \ H	5.5	7.0
1.0	IHCARN5510M	IHCARN5510L
1.5	IHCARN5515M	IHCARN5515L
2.0	IHCARN5520M	IHCARN5520L
2.5	IHCARN5525M	IHCARN5525L
3.0	IHCARN5530M	IHCARN5530L
3.5	IHCARN5535M	IHCARN5535L
4.0	IHCARN5540M	IHCARN5540L

• Ti-Screw code : IHASR

- Abutment + Screw order code : A+Product code(ex : AIHCARN5520MC)
- Tightening torque : 30Ncm      • Use the hex driver

CEMENT

S

D

N

# Cement Abutment(NON-HEX TYPE)

## Regular Ø6.0

CEMENT

S  
D  
N

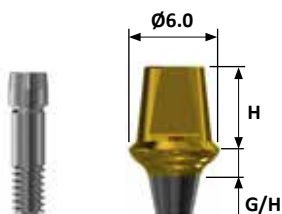

Regular Ø6.0		
G/H \ H	5.5	7.0
1.0	IHCARN6010M	IHCARN6010L
1.5	IHCARN6015M	IHCARN6015L
2.0	IHCARN6020M	IHCARN6020L
2.5	IHCARN6025M	IHCARN6025L
3.0	IHCARN6030M	IHCARN6030L
3.5	IHCARN6035M	IHCARN6035L
4.0	IHCARN6040M	IHCARN6040L

• Ti-Screw code : IHASR

## Regular Ø6.5

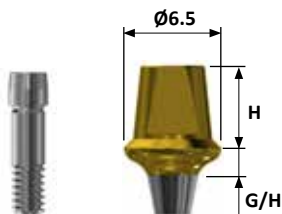

Regular Ø6.5		
G/H \ H	5.5	7.0
1.0	IHCARN6510M	IHCARN6510L
1.5	IHCARN6515M	IHCARN6515L
2.0	IHCARN6520M	IHCARN6520L
2.5	IHCARN6525M	IHCARN6525L
3.0	IHCARN6530M	IHCARN6530L
3.5	IHCARN6535M	IHCARN6535L
4.0	IHCARN6540M	IHCARN6540L

• Ti-Screw code : IHASR

- Abutment + Screw order code : A+Product code(ex : AIHCARN6520MC)
- Tightening torque : 30Ncm
- Use the hex driver

# Angled Abutment(HEX TYPE)

- Used for the path adjustment of prosthesis
- 11°taper connection for excellent safety
- Functions as a double hex type(A and B hex types)
- Packing unit : Abutment + Ti-screw

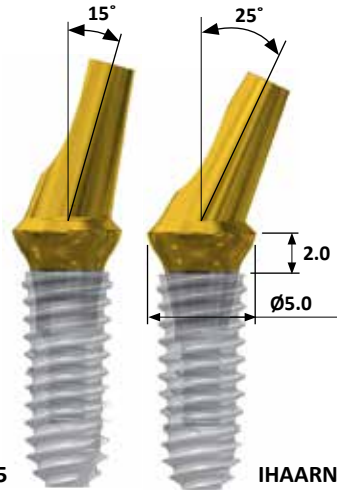

IHAARA502015

IHAARN502025

ANGLED

S

D

N

## Mini Ø4.5

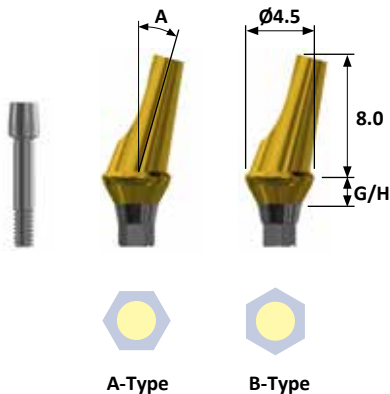

A-Type

B-Type

Mini Ø4.5			
Type	A G/H	15°	25°
A	2.0	IHAAMA452015	IHAAMA452025
	3.0	IHAAMA453015	IHAAMA453025
	4.0	IHAAMA454015	IHAAMA454025
B	2.0	IHAAMB452015	IHAAMB452025
	3.0	IHAAMB453015	IHAAMB453025
	4.0	IHAAMB454015	IHAAMB454025

• Ti-Screw code : IHASM

- Abutment + Screw order code : A+Product code(ex : AIHAAMA452015C)
- Tightening torque : 20Ncm      • Use the hex driver

# Angled Abutment(HEX TYPE)

## Regular $\varnothing 4.5$

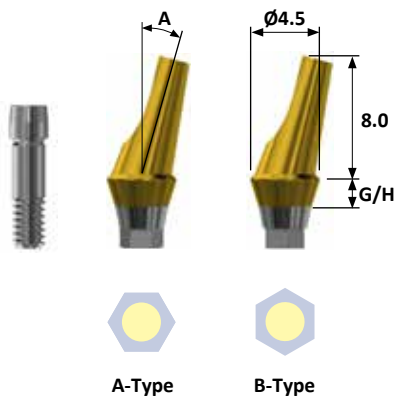

Regular $\varnothing 4.5$				
Type	A		15°	25°
	G/H			
A	2.0		IHAARA452015	IHAARA452025
	3.0		IHAARA453015	IHAARA453025
	4.0		IHAARA454015	IHAARA454025
B	2.0		IHAARB452015	IHAARB452025
	3.0		IHAARB453015	IHAARB453025
	4.0		IHAARB454015	IHAARB454025

• Ti-Screw code : IHASR

## Regular $\varnothing 5.0$

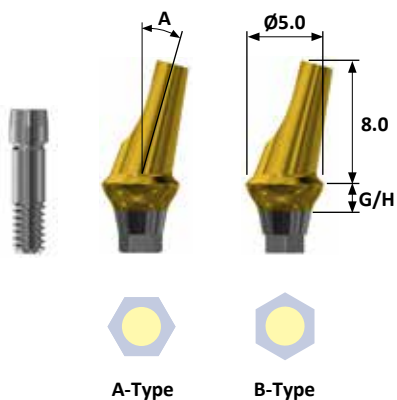

Regular $\varnothing 5.0$				
Type	A		15°	25°
	G/H			
A	2.0		IHAARA502015	IHAARA502025
	3.0		IHAARA503015	IHAARA503025
	4.0		IHAARA504015	IHAARA504025
B	2.0		IHAARB502015	IHAARB502025
	3.0		IHAARB503015	IHAARB503025
	4.0		IHAARB504015	IHAARB504025

• Ti-Screw code : IHASR

- Abutment + Screw order code : A+Product code(ex : AIHAARA452015C)
- Tightening torque : 30Ncm      • Use the hex driver



# Angled Abutment(HEX TYPE)

## Regular Ø5.5

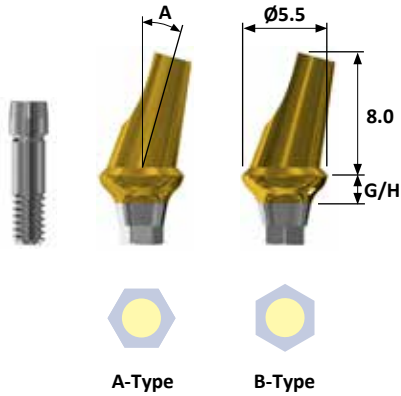

Regular Ø5.5				
Type	A		15°	25°
	G/H			
A	2.0		IHAARA552015	IHAARA552025
	3.0		IHAARA553015	IHAARA553025
	4.0		IHAARA554015	IHAARA554025
B	2.0		IHAARB552015	IHAARB552025
	3.0		IHAARB553015	IHAARB553025
	4.0		IHAARB554015	IHAARB554025

• Ti-Screw code : IHASR

## Regular Ø6.0

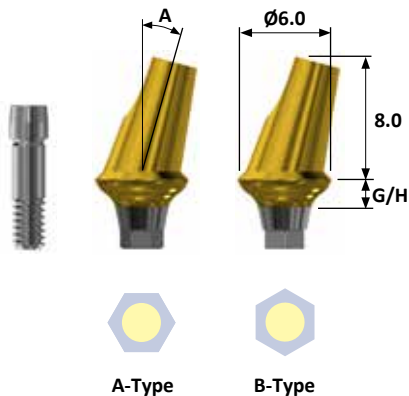

Regular Ø6.0				
Type	A		15°	25°
	G/H			
A	2.0		IHAARA602015	IHAARA602025
	3.0		IHAARA603015	IHAARA603025
	4.0		IHAARA604015	IHAARA604025
B	2.0		IHAARB602015	IHAARB602025
	3.0		IHAARB603015	IHAARB603025
	4.0		IHAARB604015	IHAARB604025

• Ti-Screw code : IHASR

- Abutment + Screw order code : A+Product code(ex : AIHAARA552015C)
- Tightening torque : 30Ncm
- Use the hex driver

# Angled Abutment(HEX D-TYPE)

## Regular $\varnothing 4.5$

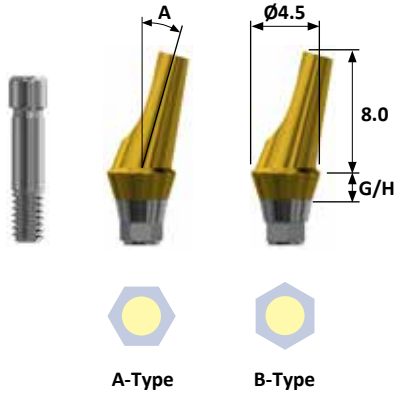

Regular $\varnothing 4.5$				
Type	A		15°	25°
	G/H			
A	2.0		IHAARA452015D	IHAARA452025D
	3.0		IHAARA453015D	IHAARA453025D
	4.0		IHAARA454015D	IHAARA454025D
B	2.0		IHAARB452015D	IHAARB452025D
	3.0		IHAARB453015D	IHAARB453025D
	4.0		IHAARB454015D	IHAARB454025D

• Ti-Screw code : IHASD128

## Regular $\varnothing 5.0$

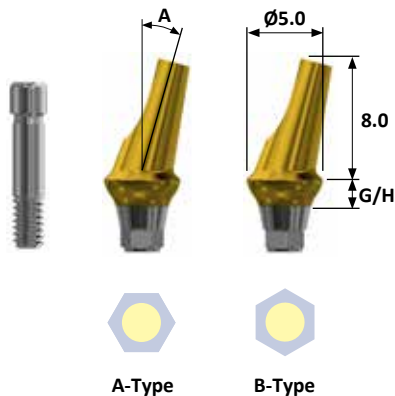

Regular $\varnothing 5.0$				
Type	A		15°	25°
	G/H			
A	2.0		IHAARA502015D	IHAARA502025D
	3.0		IHAARA503015D	IHAARA503025D
	4.0		IHAARA504015D	IHAARA504025D
B	2.0		IHAARB502015D	IHAARB502025D
	3.0		IHAARB503015D	IHAARB503025D
	4.0		IHAARB504015D	IHAARB504025D

• Ti-Screw code : IHASD128

- Abutment + Screw order code : A+Product code(ex : AIHAARA452015D)
- Tightening torque : 30Ncm      • Use the hex driver

# Angled Abutment(HEX D-TYPE)

## Regular Ø5.5

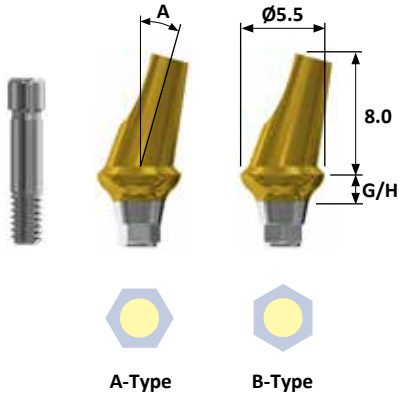

Regular Ø5.5				
Type	A		15°	25°
	G/H			
A	2.0		IHAARA552015D	IHAARA552025D
	3.0		IHAARA553015D	IHAARA553025D
	4.0		IHAARA554015D	IHAARA554025D
B	2.0		IHAARB552015D	IHAARB552025D
	3.0		IHAARB553015D	IHAARB553025D
	4.0		IHAARB554015D	IHAARB554025D

• Ti-Screw code : IHASD128

## Regular Ø6.0

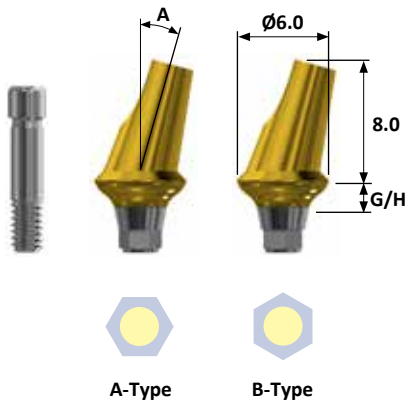

Regular Ø6.0				
Type	A		15°	25°
	G/H			
A	2.0		IHAARA602015D	IHAARA602025D
	3.0		IHAARA603015D	IHAARA603025D
	4.0		IHAARA604015D	IHAARA604025D
B	2.0		IHAARB602015D	IHAARB602025D
	3.0		IHAARB603015D	IHAARB603025D
	4.0		IHAARB604015D	IHAARB604025D

• Ti-Screw code : IHASD128

- Abutment + Screw order code : A+Product code(ex : AIHAARA552015D)
- Tightening torque : 30Ncm      • Use the hex driver

# Angled Abutment(NON-HEX TYPE)

## Mini Ø4.5

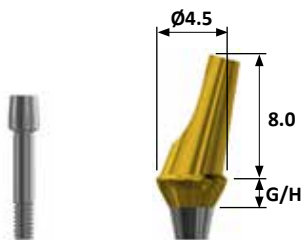

Mini Ø4.5		
G/H \ A	15°	25°
2.0	IHAAMN452015	IHAAMN452025
3.0	IHAAMN453015	IHAAMN453025
4.0	IHAAMN454015	IHAAMN454025

• Ti-Screw code : IHASM

## Regular Ø4.5

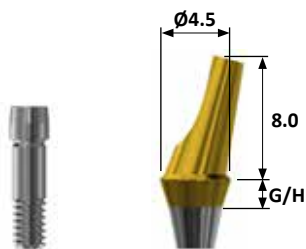

Regular Ø4.5		
G/H \ A	15°	25°
2.0	IHAARN452015	IHAARN452025
3.0	IHAARN453015	IHAARN453025
4.0	IHAARN454015	IHAARN454025

• Ti-Screw code : IHASR

## Regular Ø5.0

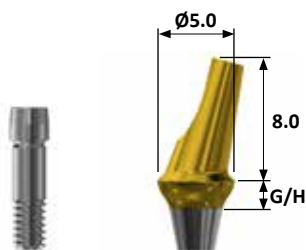

Regular Ø5.0		
G/H \ A	15°	25°
2.0	IHAARN502015	IHAARN502025
3.0	IHAARN503015	IHAARN503025
4.0	IHAARN504015	IHAARN504025

• Ti-Screw code : IHASR

- Abutment + Screw order code : A+Product code(ex : AIHAARN452015C)
- Tightening torque : Mini-20Ncm, Regular-30Ncm
- Use the hex driver

# Angled Abutment(NON-HEX TYPE)

## Regular $\varnothing 5.5$

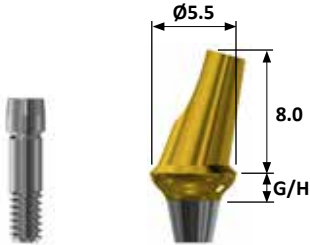

Regular $\varnothing 5.5$		
G/H \ A	15°	25°
2.0	IHAARN552015	IHAARN552025
3.0	IHAARN553015	IHAARN553025
4.0	IHAARN554015	IHAARN554025

• Ti-Screw code : IHASR

## Regular $\varnothing 6.0$

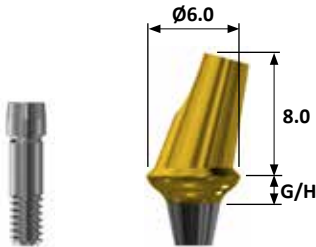

Regular $\varnothing 6.0$		
G/H \ A	15°	25°
2.0	IHAARN602015	IHAARN602025
3.0	IHAARN603015	IHAARN603025
4.0	IHAARN604015	IHAARN604025

• Ti-Screw code : IHASR

ANGLED

S

D

N

- Abutment + Screw order code : A+Product code(ex : AIHAARN552015C)
- Tightening torque : 30Ncm      • Use the hex driver

## FreeMilling Abutment(HEX TYPE)

FREEMILLING

S

D

N

- Use for the path adjustment of abutments or customization of prosthetic margin
- 11°taper connection for excellent safety
- Packing unit : Abutment + Ti-screw

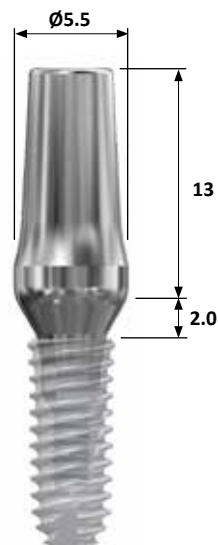

IHFMRH5520

### Mini Ø4.5

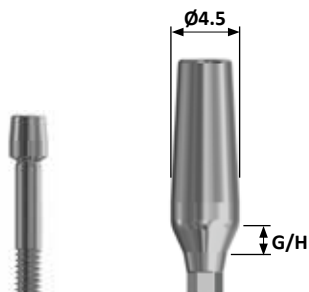

Mini Ø4.5	
G/H	Code
1.0	IHFMMH4510
2.0	IHFMMH4520
3.0	IHFMMH4530

• Ti-Screw code : IHASM

- Abutment + Screw order code : A+Product code(ex : AIHFMMH4520)
- Tightening torque : 20Ncm
- Use the hex driver

# FreeMilling Abutment(HEX TYPE)

## Regular Ø4.5

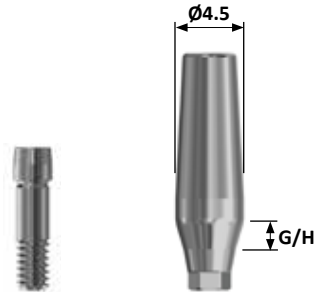

Regular Ø4.5	
G/H	Code
1.0	IHFMRH4510
2.0	IHFMRH4520
3.0	IHFMRH4530

• Ti-Screw code : IHASR

## Regular Ø5.0



Regular Ø5.0	
G/H	Code
1.0	IHFMRH5010
2.0	IHFMRH5020
3.0	IHFMRH5030

• Ti-Screw code : IHASR

## Regular Ø5.5

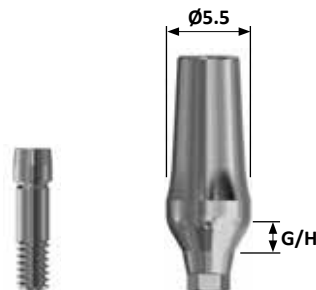

Regular Ø5.5	
G/H	Code
1.0	IHFMRH5510
2.0	IHFMRH5520
3.0	IHFMRH5530

• Ti-Screw code : IHASR

- Abutment + Screw order code : A+Product code(ex : AIHFMRH5020)
- Tightening torque : 30Ncm
- Use the hex driver

## FreeMilling Abutment(HEX TYPE)

### Regular Ø6.0

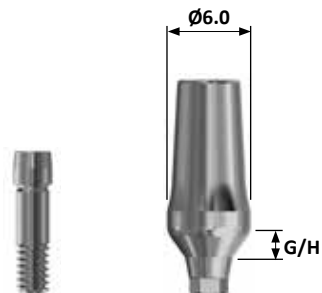

Regular Ø6.0	
G/H	Code
1.0	IHFMRH6010
2.0	IHFMRH6020
3.0	IHFMRH6030

• Ti-Screw code : IHASR

### Regular Ø6.5

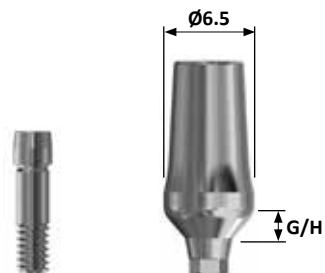

Regular Ø6.5	
G/H	Code
1.0	IHFMRH6510
2.0	IHFMRH6520
3.0	IHFMRH6530

• Ti-Screw code : IHASR

- Abutment + Screw order code : A+Product code(ex : AIHFMRH6020)
- Tightening torque : 30Ncm
- Use the hex driver



# FreeMilling Abutment(HEX D-TYPE)

## Regular Ø4.5

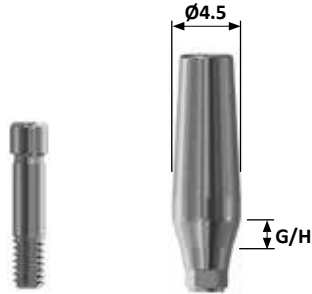

Regular Ø4.5	
G/H	Code
1.0	IHFMRH4510D
2.0	IHFMRH4520D
3.0	IHFMRH4530D

• Ti-Screw code : IHASD128

## Regular Ø5.0

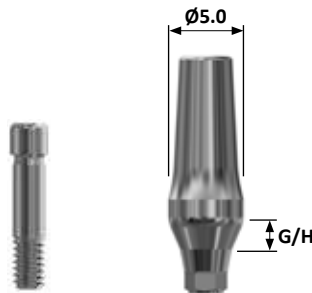

Regular Ø5.0	
G/H	Code
1.0	IHFMRH5010D
2.0	IHFMRH5020D
3.0	IHFMRH5030D

• Ti-Screw code : IHASD128

## Regular Ø5.5



Regular Ø5.5	
G/H	Code
1.0	IHFMRH5510D
2.0	IHFMRH5520D
3.0	IHFMRH5530D

• Ti-Screw code : IHASD128

- Abutment + Screw order code : A+Product code(ex : AIHFMRH5020D)
- Tightening torque : 30Ncm
- Use the hex driver

# FreeMilling Abutment(HEX D-TYPE)

## Regular Ø6.0

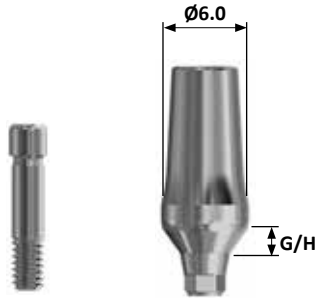

Regular Ø6.0	
G/H	Code
1.0	IHFMRH6010D
2.0	IHFMRH6020D
3.0	IHFMRH6030D

• Ti-Screw code : IHASD128

## Regular Ø6.5

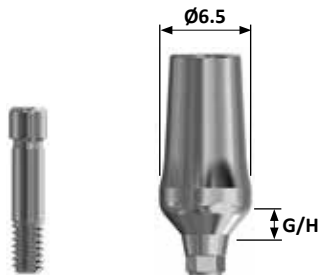

Regular Ø6.5	
G/H	Code
1.0	IHFMRH6510D
2.0	IHFMRH6520D
3.0	IHFMRH6530D

• Ti-Screw code : IHASD128

- Abutment + Screw order code : A+Product code(ex : AIHFMRH6020D)
- Tightening torque : 30Ncm
- Use the hex driver

# FreeMilling Abutment(NON-HEX TYPE)

## Mini Ø4.5

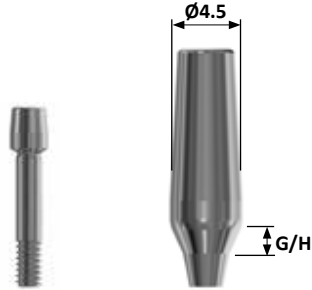

Mini Ø4.5	
G/H	Code
1.0	IHFMMN4510
2.0	IHFMMN4520
3.0	IHFMMN4530

• Ti-Screw code : IHASM

## Regular Ø4.5

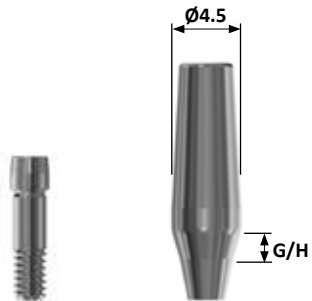

Regular Ø4.5	
G/H	Code
1.0	IHFMRN4510
2.0	IHFMRN4520
3.0	IHFMRN4530

• Ti-Screw code : IHASR

## Regular Ø5.0



Regular Ø5.0	
G/H	Code
1.0	IHFMRN5010
2.0	IHFMRN5020
3.0	IHFMRN5030

• Ti-Screw code : IHASR

- Abutment + Screw order code : A+Product code(ex : AIHFMRN5020)
- Tightening torque : Mini-20Ncm, Regular-30Ncm      • Use the hex driver

# FreeMilling Abutment(NON-HEX TYPE)

## Regular Ø5.5

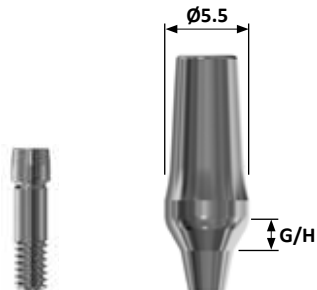

Regular Ø5.5	
G/H	Code
1.0	IHFMRN5510
2.0	IHFMRN5520
3.0	IHFMRN5530

• Ti-Screw code : IHASR

## Regular Ø6.0

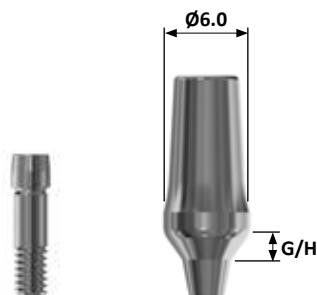

Regular Ø6.0	
G/H	Code
1.0	IHFMRN6010
2.0	IHFMRN6020
3.0	IHFMRN6030

• Ti-Screw code : IHASR

## Regular Ø6.5

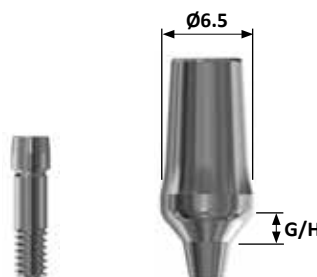

Regular Ø6.5	
G/H	Code
1.0	IHFMRN6510
2.0	IHFMRN6520
3.0	IHFMRN6530

• Ti-Screw code : IHASR

- Abutment + Screw order code : A+Product code(ex : AIHFMRN6020)
- Tightening torque : 30Ncm
- Use the hex driver

# CCM Casting Abutment

- Used in producing screw-retained prosthetics
- Used when path, aesthetics, or space have limitations
- CCM casting abutment replaces expensive gold to alleviate financial burden to all.
- Abutment region fusion range : 1400°C~1550°C
- Packing unit : Abutment + Sleeve + Ti-screw



IHCCARH4510

CCM CASTING

S

D

N

## Mini Ø4.0



Mini Ø4.0		
G/H	Hex	Non-Hex
1.0	IHCCAMH4010	IHCCAMN4010
3.0	IHCCAMH4030	IHCCAMN4030

• Ti-Screw code : IHASM

- Abutment + Screw order code : A+Product code(ex : AIHCCAMH4010)
- Tightening torque : 20Ncm
- Use the hex driver

# CCM Casting Abutment

## Regular Ø4.5



Regular Ø4.5		
G/H	Hex	Non-Hex
1.0	IHCCARH4510	IHCCARN4510
3.0	IHCCARH4530	IHCCARN4530

• Ti-Screw code : IHASR

## Regular D-type Ø4.5

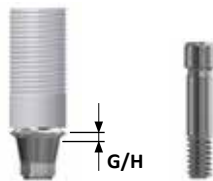

Regular D-type Ø4.5	
G/H	Hex
1.0	IHCCARH4510D
3.0	IHCCARH4530D

• Ti-Screw code : IHASD128

- Abutment + Screw order code : A+Product code(ex : AIHCCARH4510)
- Tightening torque : 30Ncm
- Use the hex driver

# Temporary Abutment(HEX TYPE)

- Use to make temporary prosthesis
- 11°taper connection for excellent safety
- Packing unit : Abutment + Ti-screw

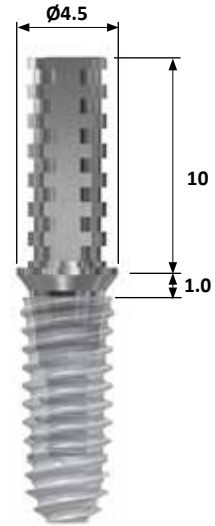

IHTARH4510

TEMPORARY

S

D

N

## Mini Ø4.0

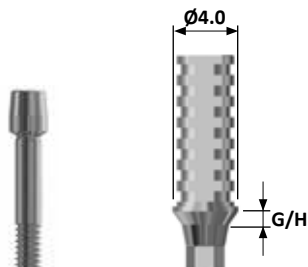

Mini Ø4.0	
G/H	Code
1.0	IHTAMH4010
3.0	IHTAMH4030

• Ti-Screw code : IHASM

- Abutment + Screw order code : A+Product code(ex : AIHTAMH4010)
- Tightening torque : 20Ncm
- Use the hex driver

## Temporary Abutment(HEX TYPE)

Regular  $\varnothing 4.5$

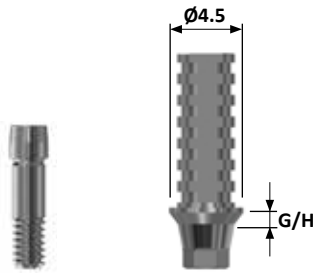

Regular $\varnothing 4.5$	
G/H	Code
1.0	IHTARH4510
3.0	IHTARH4530

• Ti-Screw code : IHASR

## Temporary Abutment(HEX D-TYPE)

Regular  $\varnothing 4.5$

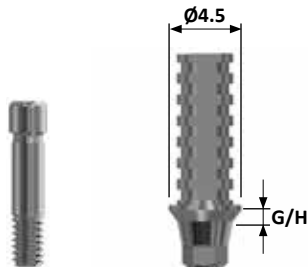

Regular $\varnothing 4.5$	
G/H	Code
1.0	IHTARH4510D
3.0	IHTARH4530D

• Ti-Screw code : IHASD128

- Abutment + Screw order code : A+Product code(ex : AIHTARH4510)
- Tightening torque : 20Ncm
- Use the hex driver



# Temporary Abutment(NON-HEX TYPE)

## Mini Ø4.0

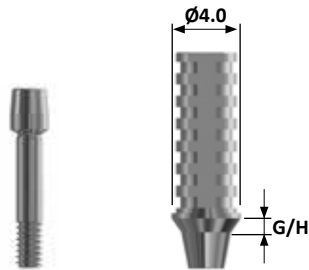

Mini Ø4.0	
G/H	Code
1.0	IHTAMN4010
3.0	IHTAMN4030

• Ti-Screw code : IHASM

TEMPORARY

S

D

N

## Regular Ø4.5

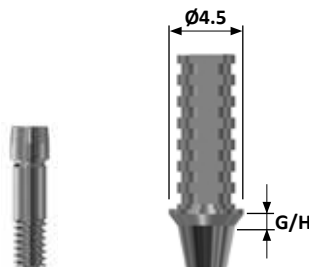

Regular Ø4.5	
G/H	Code
1.0	IHTARN4510
3.0	IHTARN4530

• Ti-Screw code : IHASR

- Abutment + Screw order code : A+Product code(ex : AIHTARN4510)
- Tightening torque : 20Ncm
- Use the hex driver

# Fixture Level Impression Coping Pick-up type

Mini  $\varnothing 4.0 / \varnothing 4.5$

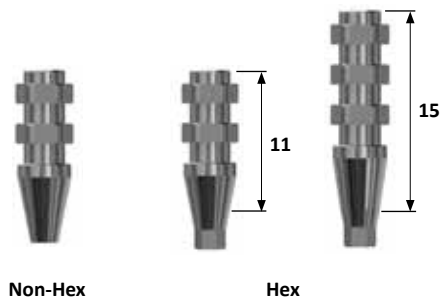

Mini $\varnothing 4.0/4.5$		
L	Hex	Non-Hex
11	IHPIMH4011	IHPIMN4011
	IHPIMH4511	IHPIMN4511
15	IHPIMH4015	IHPIMN4015
	IHPIMH4515	IHPIMN4515

## Guide Pin

Mini



Mini	
Size	Code
Short	IHPIGPM100
Middle	IHPIGPM150
Long	IHPIGPM150L

Regular



Regular		
Size	Code	
Short	IHPIGPR100	IHPIGPR100D
Middle	IHPIGPR150	IHPIGPR150D
Long	IHPIGPR150L	IHPIGPR150LD

- Pick-up type for taking an impression using a customized tray
- Packing unit : Impression body + Guide pin
- Use the hex driver

# Fixture Level Impression Coping Pick-up type

## Regular Ø4.0

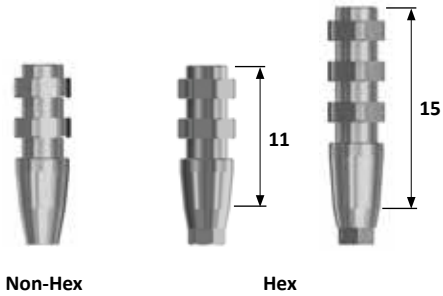

Regular Ø4.0		
L	Hex	Non-Hex
11	IHPIRH4011	IHPIRN4011
15	IHPIRH4015	IHPIRN4015

## Regular Ø4.5

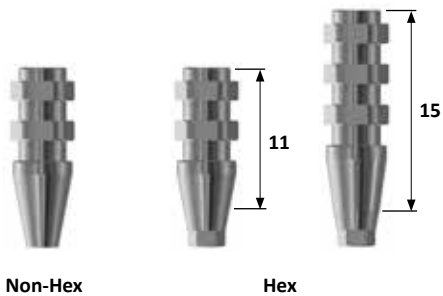

Regular Ø4.5		
L	Hex	Non-Hex
11	IHPIRH4511	IHPIRN4511
15	IHPIRH4515	IHPIRN4515

## Regular Ø5.0

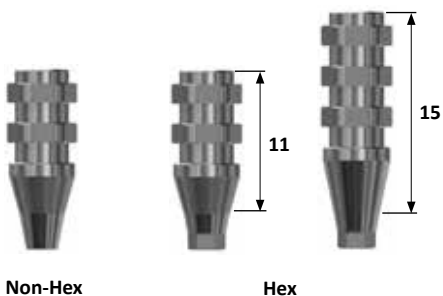

Regular Ø5.0		
L	Hex	Non-Hex
11	IHPIRH5011	IHPIRN5011
15	IHPIRH5015	IHPIRN5015

- Pick-up type for taking an impression using a customized tray
- Packing unit : Impression body + Guide pin
- Use the hex driver

# Fixture Level Impression Coping Pick-up type

## Regular Ø5.5

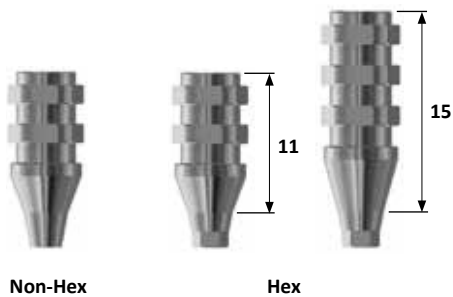

Regular Ø5.5		
L	Hex	Non-Hex
11	IHPIRH5511	IHPIRN5511
15	IHPIRH5515	IHPIRN5515

## Regular Ø6.0

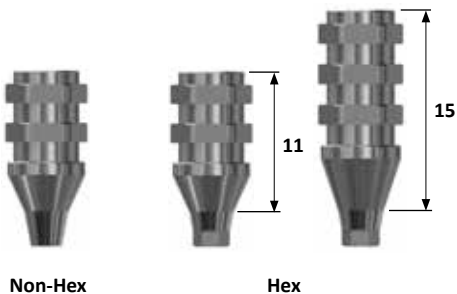

Regular Ø6.0		
L	Hex	Non-Hex
11	IHPIRH6011	IHPIRN6011
15	IHPIRH6015	IHPIRN6015

- Pick-up type for taking an impression using a customized tray
- Packing unit : Impression body + Guide pin
- Use the hex driver



IMPRESSION

S

D

N

# Fixture Level Impression Coping(HEX D-TYPE) Pick-up type

## Regular Ø4.0

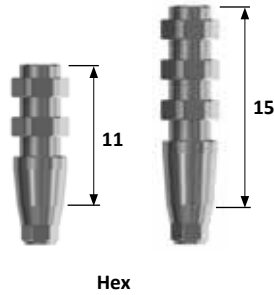

Regular Ø4.0	
L	Hex D-type
11	IHPIRH4011D
15	IHPIRH4015D

## Regular Ø4.5

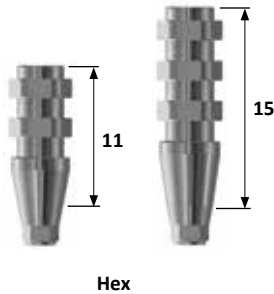

Regular Ø4.5	
L	Hex D-type
11	IHPIRH4511D
15	IHPIRH4515D

## Regular Ø5.0

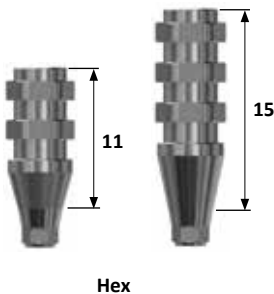

Regular Ø5.0	
L	Hex D-type
11	IHPIRH5011D
15	IHPIRH5015D

- Pick-up type for taking an impression using a customized tray
- Packing unit : Impression body + Guide pin
- Use the hex driver

# Fixture Level Impression Coping (HEX D-TYPE) Pick-up type

Regular  $\varnothing 5.5$

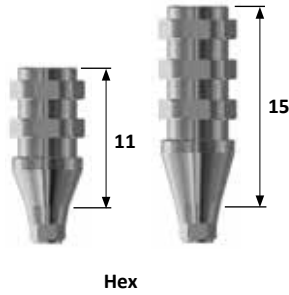

Regular $\varnothing 5.5$	
L	Hex D-type
11	IHPIRH5511D
15	IHPIRH5515D

Regular  $\varnothing 6.0$

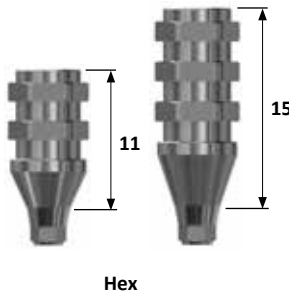

Regular $\varnothing 6.0$	
L	Hex D-type
11	IHPIRH6011D
15	IHPIRH6015D

- Pick-up type for taking an impression using a customized tray
- Packing unit : Impression body + Guide pin
- Use the hex driver

## Fixture Lab Analog

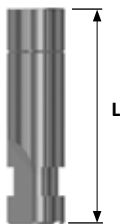

L	Mini	Regular		D-TYPE
12	IHFLAM120	IHFLAR350	IHFLAR120	IHFLAR120D
15	IHFLAM150	IHFLAR350L	IHFLAR150	IHFLAR150D

# Fixture Level Impression Coping Transfer type

## Mini Ø4.0 / Ø4.5



Mini Ø4.0		
L	Hex	Non-Hex
11	IHTIMH4011	IHTIMN4011
	IHTIMH4511	IHTIMN4511
14	IHTIMH4014	IHTIMN4014
	IHTIMH4514	IHTIMN4514

## Regular Ø4.0



Regular Ø4.0		
L	Hex	Non-Hex
11	IHTIRH4011	IHTIRN4011
14	IHTIRH4014	IHTIRN4014

## Regular Ø4.5



Regular Ø4.5		
L	Hex	Non-Hex
11	IHTIRH4511	IHTIRN4511
14	IHTIRH4514	IHTIRN4514

- Transfer type for taking an impression using a ready-made tray
- Packing unit : Hex type = Impression coping + Guide pin  
Non-Hex type = Impression coping
- Use the hex driver

# Fixture Level Impression Coping Transfer type

## Regular Ø5.0



Regular Ø5.0		
L	Hex	Non-Hex
11	IHTIRH5011	IHTIRN5011
14	IHTIRH5014	IHTIRN5014

## Regular Ø5.5

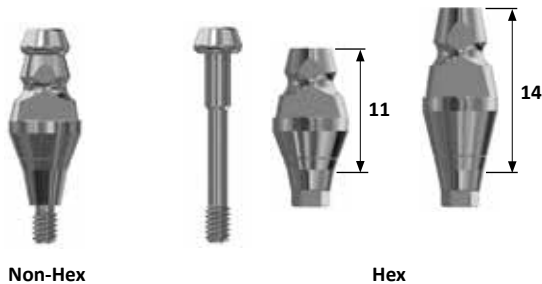

Regular Ø5.5		
L	Hex	Non-Hex
11	IHTIRH5511	IHTIRN5511
14	IHTIRH5514	IHTIRN5514

## Regular Ø6.0



Regular Ø6.0		
L	Hex	Non-Hex
11	IHTIRH6011	IHTIRN6011
14	IHTIRH6014	IHTIRN6014

- Transfer type for taking an impression using a ready-made tray
- Packing unit : Hex type = Impression coping + Guide pin  
Non-Hex type = Impression coping
- Use the hex driver



# Fixture Level Impression Coping(HEX D-TYPE) Transfer type

## Regular Ø4.0

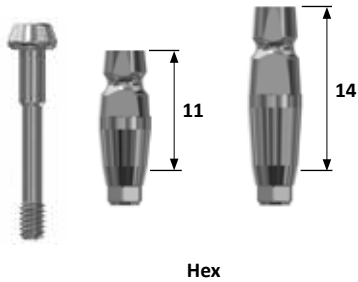

Regular Ø4.0	
L	Hex D-type
11	IHTIRH4011D
14	IHTIRH4014D

## Regular Ø4.5

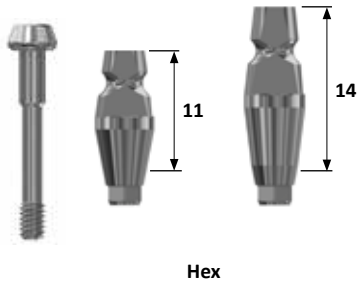

Regular Ø4.5	
L	Hex D-type
11	IHTIRH4511D
14	IHTIRH4514D

## Regular Ø5.0

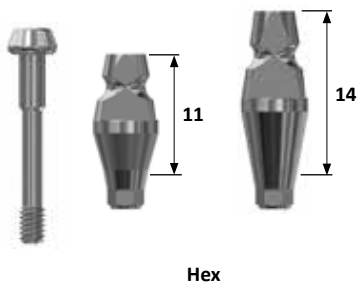

Regular Ø5.0	
L	Hex D-type
11	IHTIRH5011D
14	IHTIRH5014D

- Transfer type for taking an impression using a ready-made tray
- Packing unit : Hex type = Impression coping + Guide pin
- Use the hex driver

# Fixture Level Impression Coping (HEX D-TYPE) Transfer type

Regular  $\varnothing 5.5$

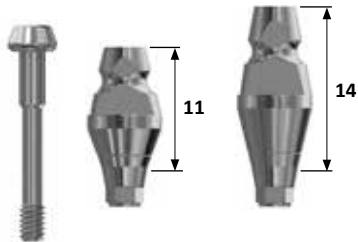

Hex

Regular $\varnothing 5.5$	
L	Hex D-type
11	IHTIRH5511D
14	IHTIRH5514D

Regular  $\varnothing 6.0$

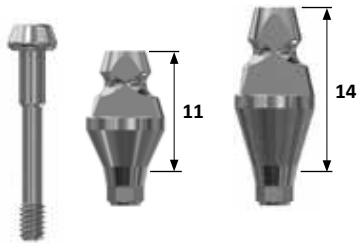

Hex

Regular $\varnothing 6.0$	
L	Hex D-type
11	IHTIRH6011D
14	IHTIRH6014D



IMPRESSION



- Transfer type for taking an impression using a ready-made tray
- Packing unit : Hex type = Impression coping + Guide pin
- Use the hex driver

# SEWON MEDIX IMPLANT SYSTEM



Prosthetic Flow Diagram 2  
**Screw Retained Restoration**  
 Multi-unit Abutment

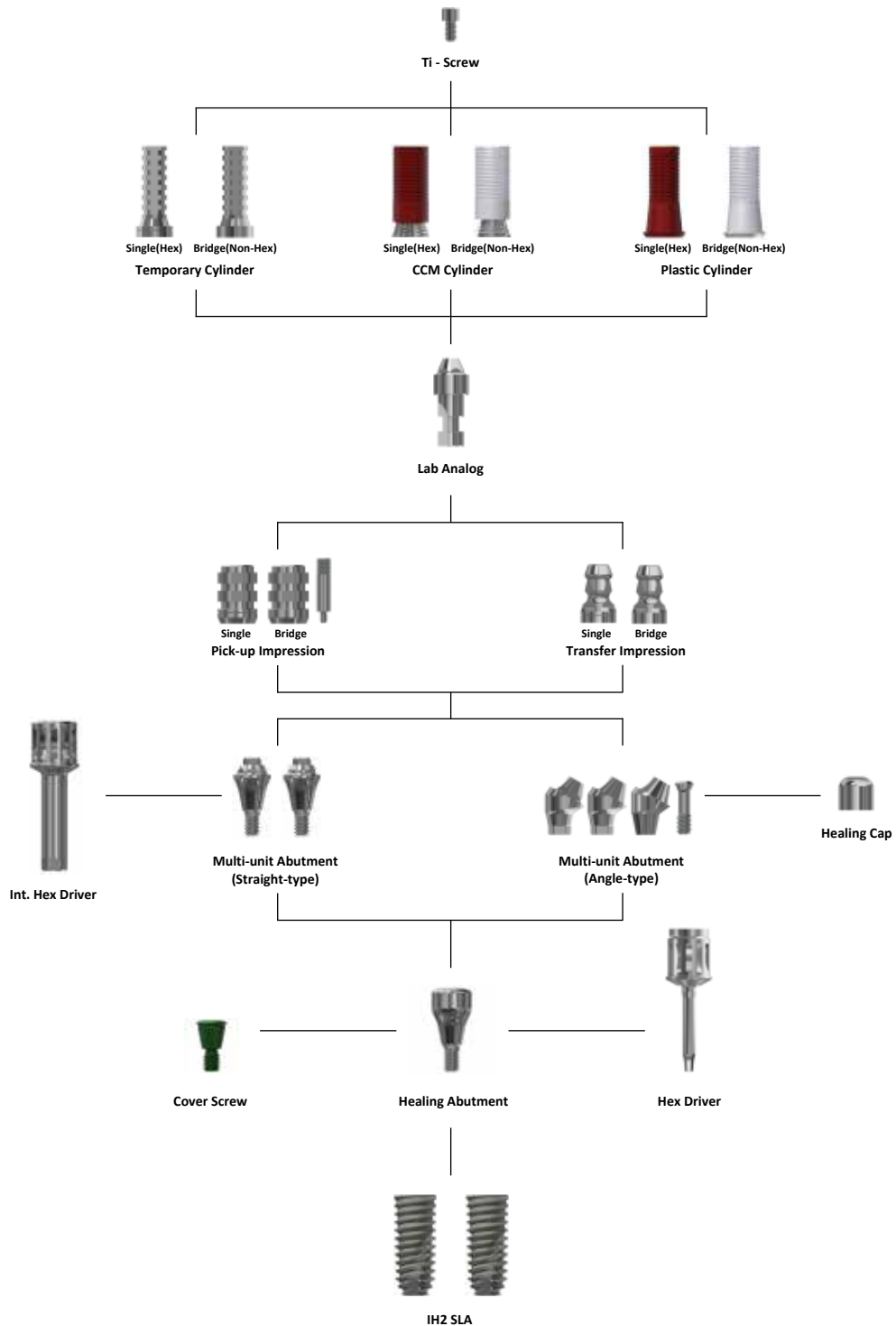

# Multi-unit Abutment

- Use for screw-retained multiple cases.
- 11°taper connection for excellent safety
- Packing unit :  
 Straight type = Abutment + Holder  
 17°/30° type = Abutment + Ti screw + Holder



## Straight type

### Mini



Mini		
G/H	Bridge	Single
1.5	IHMAM15	IHMAM15S
2.5	IHMAM25	IHMAM25S
3.5	IHMAM35	IHMAM35S
4.5	IHMAM45	IHMAM45S

### Regular



Regular		
G/H	Bridge	Single
1.5	IHMAR15	IHMAR15S
2.5	IHMAR25	IHMAR25S
3.5	IHMAR35	IHMAR35S
4.5	IHMAR45	IHMAR45S

- Abutment + Holder order code : A+Product code(ex : AIHMAR25)
- Tightening torque : 30Ncm      • Use the internal hex driver



# Multi-unit Abutment

## Mini

### 17° Multi-unit Abutment

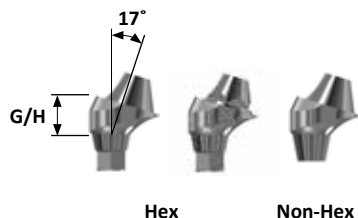

Mini 17° Multi-unit Abutment			
Fixture	Hex		Non-Hex
Cylinder	Bridge	Single	Bridge
2.5	IHMAMH2517	IHMAMH2517S	IHMAMN2517
3.0	IHMAMH3017	IHMAMH3017S	IHMAMN3017
4.0	IHMAMH4017	IHMAMH4017S	IHMAMN4017

• Ti-Screw code : IHMASM200

MULTI-UNIT

### 30° Multi-unit Abutment

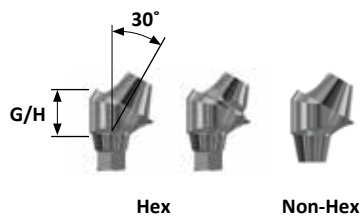

Mini 30° Multi-unit Abutment			
Fixture	Hex		Non-Hex
Cylinder	Bridge	Single	Bridge
3.5	IHMAMH3530	IHMAMH3530S	IHMAMN3530
4.0	IHMAMH4030	IHMAMH4030S	IHMAMN4030
5.0	IHMAMH5030	IHMAMH5030S	IHMAMN5030

• Ti-Screw code : IHMASM200

- Order code : A+Product code(ex : AIHMAMH3517)
- Tightening torque : 30Ncm
- Use the hex driver

# Multi-unit Abutment

## Regular

### 17° Multi-unit Abutment

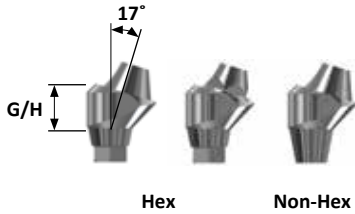

Regular 17° Multi-unit Abutment			
Fixture	Hex		Non-Hex
Cylinder	Bridge	Single	Bridge
2.5	IHMARH2517	IHMARH2517S	IHMARN2517
3.0	IHMARH3017	IHMARH3017S	IHMARN3017
4.0	IHMARH4017	IHMARH4017S	IHMARN4017

• Ti-Screw code : IHMASR200

### 30° Multi-unit Abutment

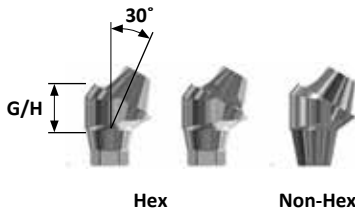

Regular 30° Multi-unit Abutment			
Fixture	Hex		Non-Hex
Cylinder	Bridge	Single	Bridge
3.5	IHMARH3530	IHMARH3530S	IHMARN3530
4.0	IHMARH4030	IHMARH4030S	IHMARN4030
5.0	IHMARH5030	IHMARH5030S	IHMARN5030

• Ti-Screw code : IHMASR200

- Order code : A+Product code(ex : AIHMARH3517)
- Tightening torque : 30Ncm
- Use the hex driver

# Multi-unit Abutment(D-TYPE)

## 17° Multi-unit Abutment

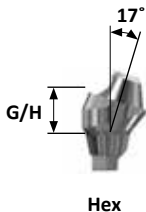

17° Multi-unit Abutment D-type	
G/H	Hex D-type
2.5	IHMARH2517D
3.5	IHMARH3517D

• Ti-Screw code : MARSD200

MULTI-UNIT

## 30° Multi-unit Abutment

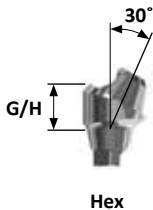

30° Multi-unit Abutment D-type	
G/H	Hex D-type
3.5	IHMARH3530D
4.5	IHMARH4530D

• Ti-Screw code : MARSD200

- Order code : A+Product code(ex : AIHMARH3517D)
- Tightening torque : 30Ncm
- Use the hex driver



# Multi-unit Abutment Components

## Healing Cap

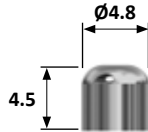

Code
MHC480H

- Use the hex driver
- Tightening torque : 20Ncm
- Packing unit : Healing cap

## CCM Cylinder

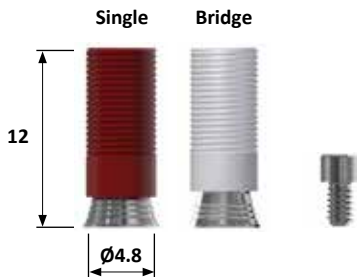

Screw	Bridge(Non-Hex)	Single(Hex)
CS200	MCC100H	MCC200H

- Use the hex driver
- Tightening torque : 20Ncm
- Packing unit : Cylinder + Sleeve + Screw
- The prosthesis is made of alloy casting
- Cylinder + screw order code : A+Product code(ex : AMCC100H)

# Multi-unit Abutment Components

## Plastic Cylinder

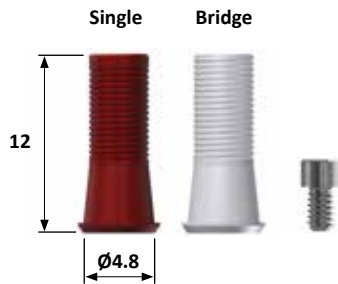

Screw	Bridge(Non-Hex)	Single(Hex)
CS200	MPC100H	MPC200H

- Use the hex driver
- Tightening torque : 20Ncm
- Packing unit : Cylinder + Screw
- The prosthesis is made of alloy casting
- Cylinder + screw order code : A+Product code(ex : AMPC100H)

MULTI-UNIT

## Temporary Cylinder

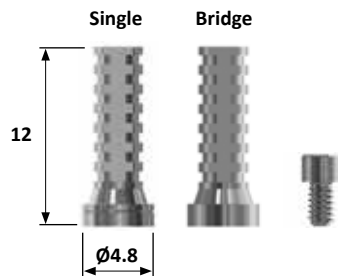

Screw	Bridge(Non-Hex)	Single(Hex)
CS200	MTC100H	MTC200H

- Use the hex driver
- Tightening torque : 20Ncm
- Packing unit : Cylinder + Screw
- Multi-unit abutment used in the making of a temporary prosthesis
- Cylinder + screw order code : A+Product code(ex : AMTC100H)

# Multi-unit Abutment Components

## Transfer Impression Coping

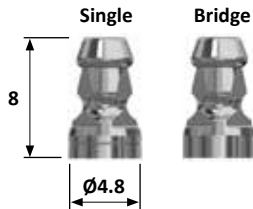

Screw	Bridge(Non-Hex)	Single(Hex)
MTICS70H	MTIC100H	MTIC200H

- Packing unit : Impression coping + Screw
- Used the hex driver
- Transfer type for taking an impression using a ready-made tray
- Impression coping + Screw Order code : A+Product code(ex : AMTIC100H)

## Pick-up Impression Coping

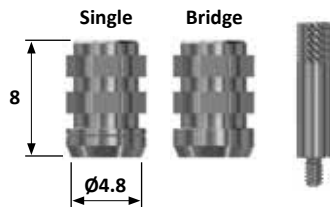

Screw	Bridge(Non-Hex)	Single(Hex)
MPIGP120H	MPIC100H	MPIC200H

- Packing unit : Impression coping + Guide pin
- Used the hex driver
- Pick-up type for taking an impression using a customized tray
- Impression coping + Screw Order code : A+Product code(ex : AMPIC100H)

## LAB Analog



Diameter	Code
Ø4.8	MLA480

- Packing unit : Lab analog
- Multi-unit abutment on a working model

# SEWON MEDIX

IMPLANT OVERDENTURE SYSTEM



Prosthetic Flow Diagram 3  
**Overdenture**  
LT/BT Abutment

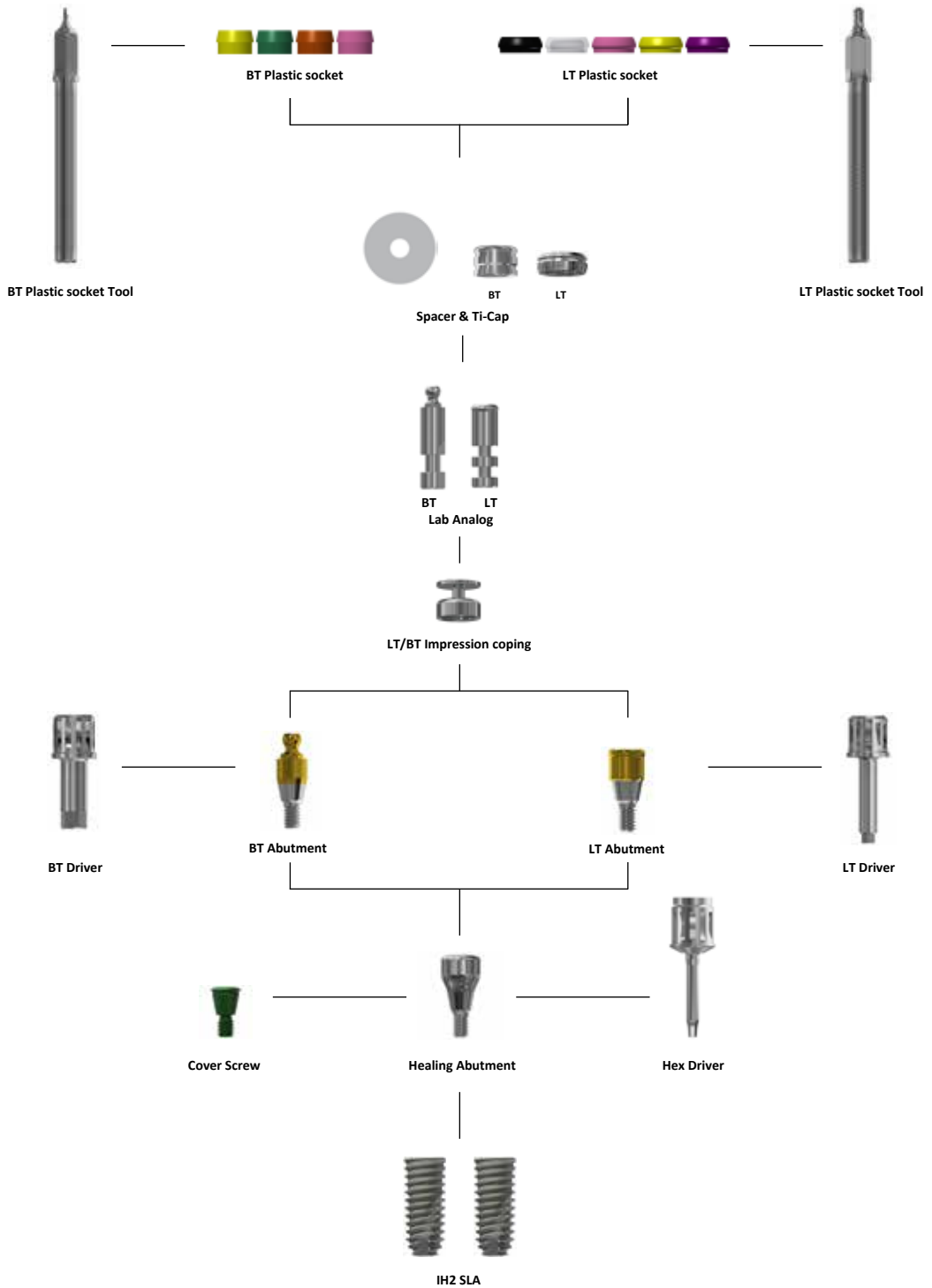

# LT Abutment

- Accommodates up to 40° divergence between two implants
- Excellent durability
- Low vertical dimension, stability, and various attachments with retention



## Mini

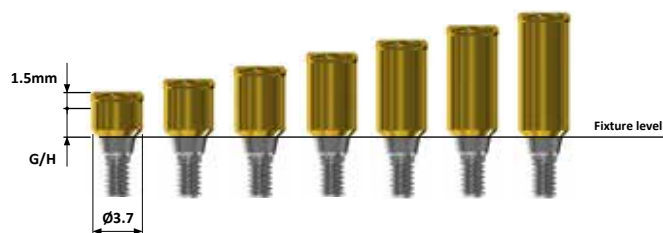

G/H	Code
1.0	IHLAM3510
2.0	IHLAM3520
3.0	IHLAM3530
4.0	IHLAM3540
5.0	IHLAM3550
6.0	IHLAM3560
7.0	IHLAM3570

## Regular



G/H	Code
1.0	IHLAR4010
2.0	IHLAR4020
3.0	IHLAR4030
4.0	IHLAR4040
5.0	IHLAR4050
6.0	IHLAR4060
7.0	IHLAR4070

- Tightening torque : 30Ncm
- Use by LT driver
- Abutment + Laboratory set order code : A+Product code+P(ex : AIHLAR4030P)

# LT Abutment Components

## LT laboratory set



Code	LPSLSP
------	--------

- Component
- Block-out spacer / Ti-cap connected black laboratory plastic socket
- Replacement Plastic socket : Yellow/Pink/Clear/Purple
- Used after selecting retention plastic sockets that are appropriate for the case
- Use Plastic socket tool to replace plastic socket
- Packing unit : 1 sets

## LT Replacement Plastic Socket

### LPSPL

- Laboratory plastic socket
- Colors : Black
- Quantity : 4 units



### LPS07P

- Retention force : 700gr(6.86N)
- 0 ~ 10°, Yellow
- Quantity : 4 units



### LPS09P

- Retention force : 900gr(8.83N)
- 0 ~ 10°, Pink
- Quantity : 4 units



### LPS15P

- Retention force : 1500gr(14.71N)
- 0 ~ 10°, Clear
- Quantity : 4 units



### LPS18P

- Retention force : 1800gr(17.65N)
- 0 ~ 10°, Purple
- Quantity : 4 units



**LT Extended Replacement Plastic Socket**

---

**LPS06NP**

---

- Retention force : 600gr(5.88N)
- 0 ~ 20°, Yellow
- Quantity : 4 units



---

**LPS08NP**

---

- Retention force : 800gr(7.84N)
- 0 ~ 20°, Pink
- Quantity : 4 units



---

**LPS10NP**

---

- Retention force : 1000gr(9.8N)
- 0 ~ 20°, Clear
- Quantity : 4 units



---

**LPS15NP**

---

- Retention force : 1500gr(14.71N)
- 0 ~ 20°, Purple
- Quantity : 4 units



---

**Block Out Spacers - LTBOS**

---

- Seals gap between denture cap and abutment
- Quantity : 10 units



---

**LT Impression coping - LTIC55**

---

- Quantity : 4 units



---

**Lab Analog - LTLA120**

---

- LT Abutment Lab Analog
- Quantity : 4 units





# LT Abutment Components

## LT Torque Driver

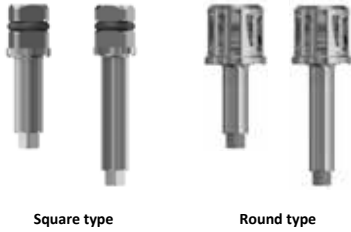

Square type

Round type

Type	Short	Long
Round	LDRS	LDRL
Square	LDSS	LDSL

- Use to tighten LT Abutment

## LT Plastic Socket Tool



LTPST

- Used in attaching and replacement plastic socket

# BT Abutment

- Ball type overdenture prostheses
- Depending on the retention force, the plastic socket comes in different colors
- Used when fixed type implant prosthesis is difficult due to severe bone or soft tissue loss
- Post part is colored in gold



## Mini



G/H	Code
1.0	IHBAM2210
2.0	IHBAM2220
3.0	IHBAM2230
4.0	IHBAM2240
5.0	IHBAM2250
6.0	IHBAM2260

## Regular



G/H	Code
1.0	IHBAR2210
2.0	IHBAR2220
3.0	IHBAR2230
4.0	IHBAR2240
5.0	IHBAR2250
6.0	IHBAR2260

- Tightening torque : 30Ncm
- Use by BT driver

# BT Abutment Components

## BT Replacement Plastic Socket

---

### BT Ti-Cap - BATC22

---

- The size of the titanium cap has been reduced to provide stability and it is designed to strengthen the coherence with resin.
- Quantity : 4 units



---

### BPS22035

---

- Retention force : 350gr(3.43N)
- 0 ~ 10°, ORANGE
- Quantity : 4 units



---

### BPS22050

---

- Retention force : 500gr(4.9N)
- 0 ~ 10°, Yellow
- Quantity : 4 units



---

### BPS22090

---

- Retention force : 900gr(8.83N)
- 0 ~ 10°, Pink
- Quantity : 4 units



---

### BPS22130

---

- Retention force : 1300gr(12.75N)
- 0 ~ 10°, AQUA
- Quantity : 4 units



---

### BT Impression coping - BTIC22

---

- Quantity : 4 units



---

### Lab Analog - BTLA22

---

- BT Abutment Lab Analog
- Quantity : 4 units



OVERDENTURE

# BT Abutment Components

## BT Torque Driver



Square type

Round type

Type	Short	Long
Round	BDRS	BDRL
Square	BDSS	BDSL

- Use to tighten BT Abutment

## BT Plastic Socket Tool



**BTPST**

- Used in attaching and replacement plastic socket

# IH SYSTEM

## Ti-Custom Block(HEX TYPE)

- Used to make customized prosthesis
- Packing unit : Ti-Block + Screw
- Tightening torque : Use according to each model

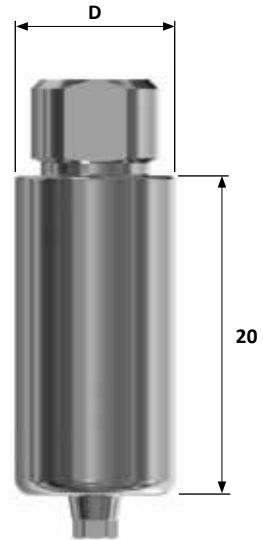

IHCBRH10

Code		Compatible Model	Screw code
Ø10	Ø14		
IHCBMH10	IHCBMH14	TS Mini, Luna Mini	IHASM
IHCBRH10	IHCBRH14	TS Regular, Luna Regular, UF Regular	IHASR
IHCBRH10D	IHCBRH14D	SuperLine, AnyOne, IS Regular	IHASD128

## Ti-Custom Block(NON-HEX TYPE)

- Used to make customized prosthesis
- Packing unit : Ti-Block + Screw
- Tightening torque : Use according to each model

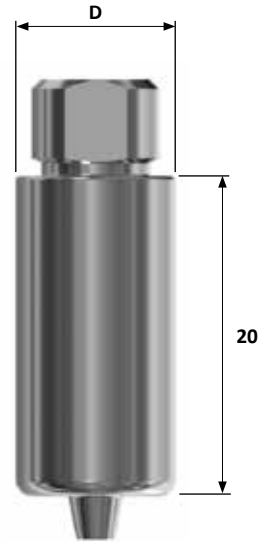

IHCBRN10

Code		Compatible Model	Screw code
∅10	∅14		
IHCBMN10	IHCBMN14	TS Mini, Luna Mini	IHASM
IHCBRN10	IHCBRN14	TS Regular, Luna Regular, UF Regular, SuperLine, AnyOne, IS Regular	IHASR

## Ti-Custom Block

Code		Compatible Model	Screw code
Ø10	Ø14		
3C34TB10	3C34TB14	BIOMET 3I, Certain, 34mm	IUNIHT
3C41TB10	3C41TB14	BIOMET 3I, Certain, 4.1mm	
3C50TB10	3C50TB14	BIOMET 3I, Certain, 5.0mm	
AATB10	AATB14	Anthogyr, Axiom	ARTS200
ARNTB10	ARNTB14	Ankylos	ATS200
BS37TB10	BS37TB14	BEGO, Semados, Ø3.25/3.75	BPSS200
BS41TB10	BS41TB14	BEGO, Semados, Ø4.1	
BS45TB10	BS45TB14	BEGO, Semados, Ø4.5	
BS55TB10	BS55TB1	BEGO, Semados, Ø5.5	
IB41RTB10	IB41RTB14	Straumann, Bone Level, RC, 4.1mm	IBNBS600
IBNTB10	IBNTB14	Straumann, Bone Level, NC, 3.3mm	IBRBS600
ITB4810	ITB4814	Straumann, Tissue Level, Ø4.8	ITBS600
ITB6510	ITB6514	Straumann, Tissue Level, Ø6.5	
AYXTB10	AYXTB14	ASTRA, Yellow	AYXTS200
AASTB10	AASTB14	ASTRA, Aqua	AASTS200
ALLTB10	ALLTB14	ASTRA, Lilac	ALLTS200
FFNTB10	FFNTB14	FMD, i-Fix, Narrow	FFNTS200
FFRTB10	FFRTB14	FMD, i-Fix, Regular	FFRTS200

• A list of products not available in the EU.



# Ti-Custom Block

Code		Compatible Model	Screw code
Ø10	Ø14		
XF30TB10	XF30TB14	XiVE, Friadent Ø3.0	XF30TS
XF34TB10	XF34TB14	XiVE, Friadent Ø3.4	XF34TS
XF38TB10	XF38TB14	XiVE, Friadent Ø3.8	
XF45TB10	XF45TB14	XiVE, Friadent Ø4.5	
XF55TB10	XF55TB14	XiVE, Friadent Ø5.5	
MNTB10	MNTB14	MIS, Internal NP	MNTS200
MSTB10	MSTB14	MIS, Internal SP	MSTS200
NRNTB10	NRNTB14	Nobelbiocare, Replace NP	NRTSN300
NRRTB10	NRRTB14	Nobelbiocare, Replace RP	NRTSR300
NRWTB10	NRWTB14	Nobelbiocare, Replace WP	
NR6TB10	NR6TB14	Nobelbiocare, Replace 6.0	
NANTB10	NANTB14	Nobelbiocare, Active NP	NATSN300
NARTB10	NARTB14	Nobelbiocare, Active RP	NATSR300
DSMNTB10	DSMNTB14	DIO, SM, Narrow	DSTSN600
DSMRTB10	DSMRTB14	DIO, SM, Regular	DSTSR600
MEMTB10	MEMTB14	MEGAGEN, EZPlus, Mini	MEMS200
MERTB10	MERTB14	MEGAGEN, EZPlus, Regular	MERS200
MEWTB10	MEWTB14	MEGAGEN, EZPlus, Wide	MEWS200

• A list of products not available in the EU.



# SEWON MEDIX IMPLANT SYSTEM

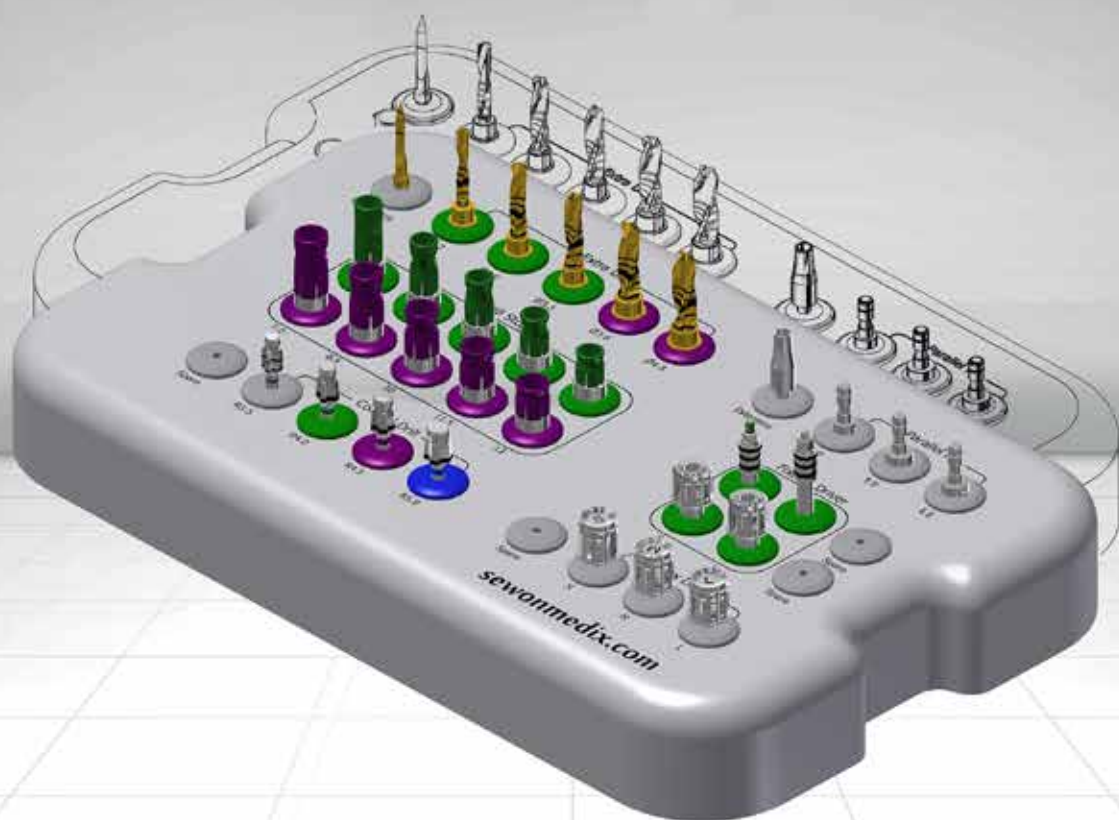

# Surgical Kit(K5:Built-in Extra drill)

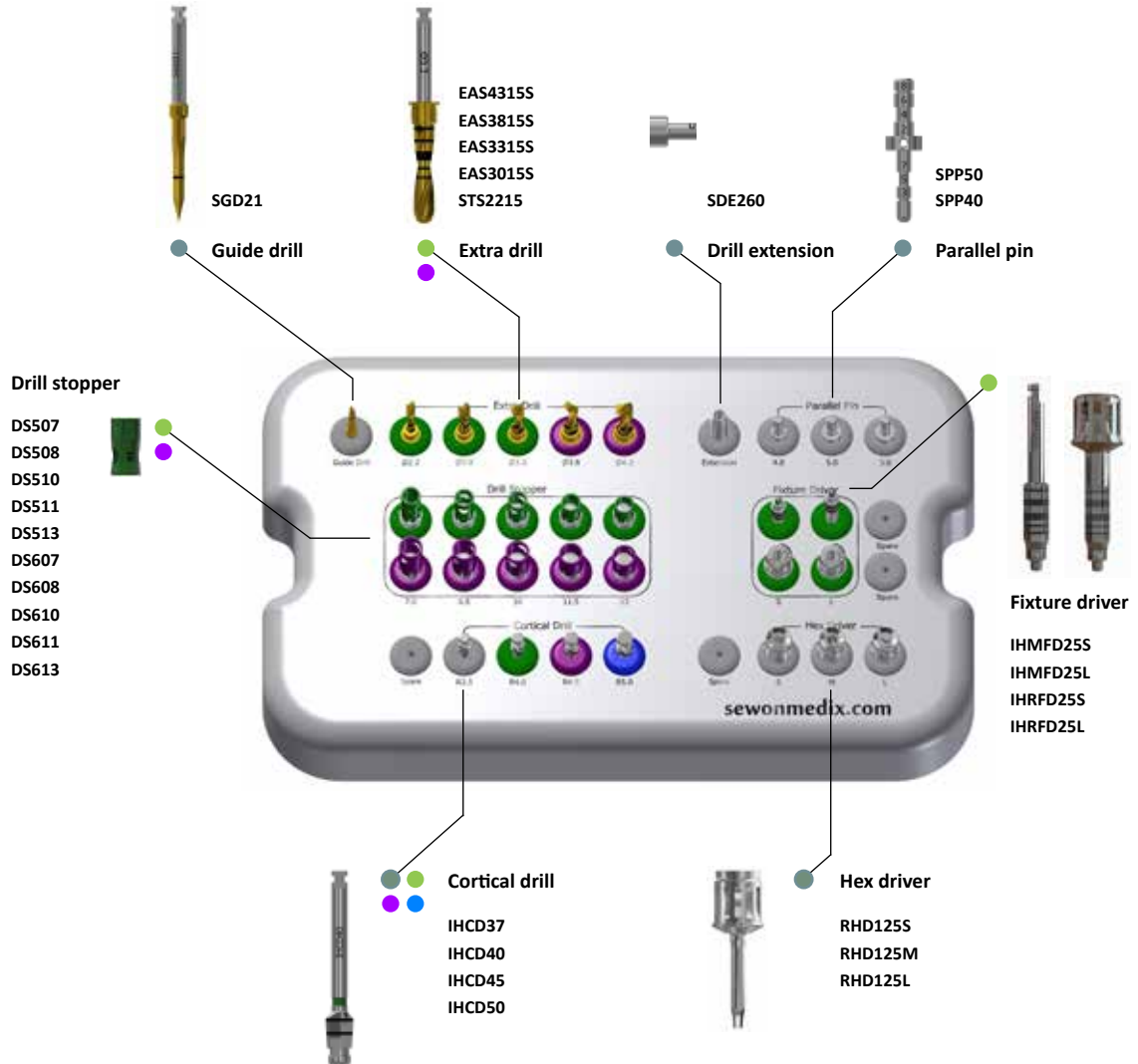

## Base components

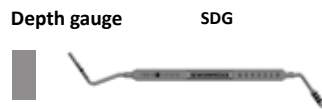
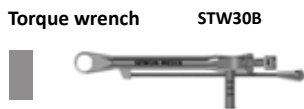

# Stopper drill Kit

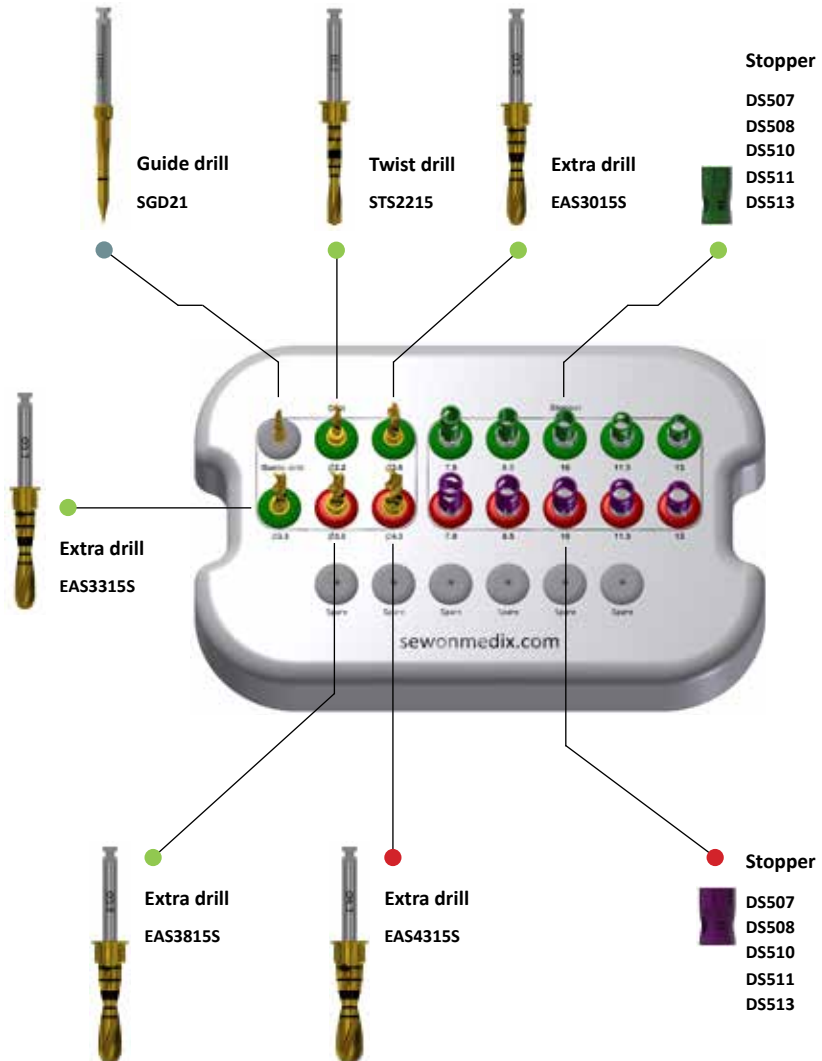

STOPPER DRILL KIT

# SEWON MEDIX IMPLANT SYSTEM



# Surgical Instruments

## Guide Drill



- Forms holes in the bone to facilitate initial drilling
- Bone density can be determined through drilling
- Tin coating improves anti corrosion and wear resistance

• Order code : SGD21

## Sidecut drill

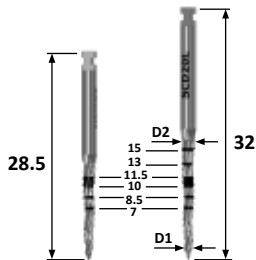

- Correct the angle or position of the osteotomy cutting edge

D1/D2	Ø1.5 / Ø2.0		Ø2.0 / Ø2.5	
Type	Short	Long	Short	Long
Code	IHSCD20S	IHSCD20L	IHSCD25S	IHSCD25L

## Drill extension



- Extends the length of a drill and other tools
- Connect the flat side of the drill handle to the flat side of the drill extension

• Order code : SDE260

## Parallel pin

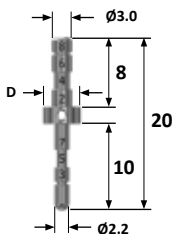

- Confirms drilling direction and location during drilling
- Predicts the diameter of an abutment to be secured

D	Code
Ø4.0	SPP40
Ø5.0	SPP50

# Surgical Instruments

## Twist drill (Initial drill)

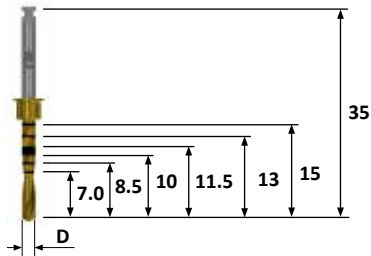

- Stopper type straight twist drill
- Tin coating improves anti corrosion and wear resistance

D	Ø2.2	Ø2.7
Code	STS2215	STS2715

## Extra drill

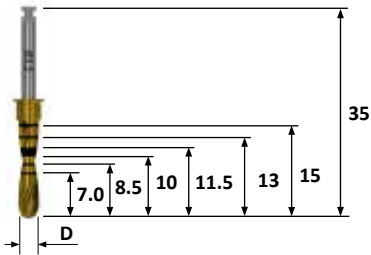

- Stopper type Extra drill
- Tin coating improves anti corrosion and wear resistance

D	Ø3.0	Ø3.3	Ø3.8	Ø4.3
Code	EAS3015	EAS3315	EAS3815	EAS4315

## Final drill

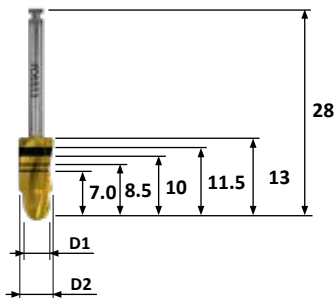

- Final drill: Dual-gear drill that has both pilot drill and twist drill capabilities
- Final drilling can be done right away without pilot drilling
- For Only Ø6.0 Fixture

D1/D2	Ø4.3/5.0	Ø4.3/5.5
Code	FD5013	FD5513



# Surgical Instruments

## Drill stopper

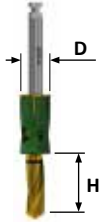

D \ H	7.0	8.5	10	11.5	13	15
Ø5.0	DS507	DS508	DS510	DS511	DS513	DS515
Ø6.0	DS607	DS608	DS610	DS611	DS613	DS615

· Color : Ø5.0-Green, Ø6.0- Purple

## Pilot drill



- Used for the path adjustment of a drilling hole
- When using the next size drill, the guide hole enables precise cutting
- Tin coating improves anti corrosion and wear resistance

Code	SPD30	SPD33	SPD38	SPD43
D1	Ø2.2	Ø2.2	Ø3.0	Ø3.0
D2	Ø3.0	Ø3.3	Ø3.8	Ø4.3

## Cortical drill



- Use after forming straight drill hole in normal & hard bone
- The color of drill handle part means the diameter and kind of main mixture to be used
- Yellow : M3.5, Gray : R3.5, Green : R4.0, Purple : R4.5, Blue : R5.0, Red : R6.0

Fixture	M3.5	R3.5	R4.0	R4.5	R5.0	R6.0
Code	IHCD35	IHCD37	IHCD40	IHCD45	IHCD50	IHCD60

# Surgical Instruments

## Fixture driver

### Mini(Ø3.5)

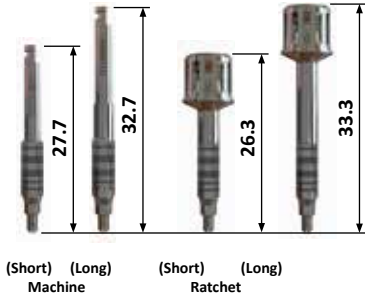

	Machine		Ratchet	
Type	Short	Long	Short	Long
Code	IHMFD21S	IHMFD21L	IHRFD21S	IHRFD21L

### Regular(Ø3.5)

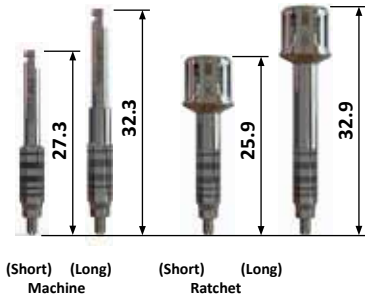

	Machine		Ratchet	
Type	Short	Long	Short	Long
Code	IHMFD25RS	IHMFD25RL	IHRFD25RS	IHRFD25RL

### Regular(Ø4.0~6.0)

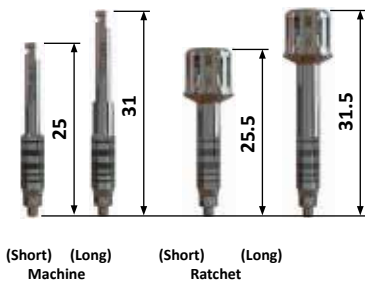

	Machine		Ratchet	
Type	Short	Long	Short	Long
Code	IHMFD25S	IHMFD25L	IHRFD25S	IHRFD25L

- Enable to place fixture without mount
- To enable the simultaneous measurement of gingival height upon treatment, laser marking are indicated at 1mm

- Limited insertion torque : 40Ncm

# Surgical Instruments

## Mount driver for Machine

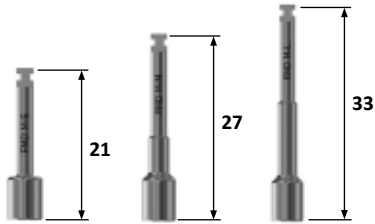

Fixture	Short	Middle	Long
Code	FMDMS	FMDMM	FMDML

## Mount driver for Ratchet

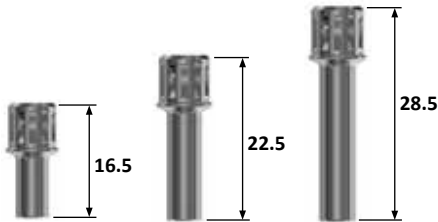

Fixture	Short	Middle	Long
Code	FMDRS	FMDRM	FMDRL

## Open Wrench



- Order code : OW700

## Depth gauge



- Use as drilling depth measurement and measurement of gingival height.
- Order code : SDG

# Surgical Instruments

## Torque wrench

### Bar type



- Range : 10~30 Ncm
- Used to adjust the implant location or tighten abutment, screw, etc.
- Apply torque after pulling bar to the line indicating torque value to be applied.
- Bar type order code : STW30B / STW50B / STW80B

### Spring type



- Range : 10~30 Ncm
- Used to adjust the implant location or tighten abutment, screw, etc.
- Can recognize the bending of the neck part of torque wrench when set torque is applied.
- If force is continuously applied when the neck of torque wrench is bent, excessive torque is applied and there can be a screw fracture issue.
- Spring type order code : STW30S

## Ratchet wrench



- Only surgical unlimited wrench.  
 (If excessive torque is applied, the inside of bone or fixture may be damaged.)
- Rotating direction is marked by an arrow for convenient identification.
- Order code : SRW

# Surgical Instruments

## Tissue punch

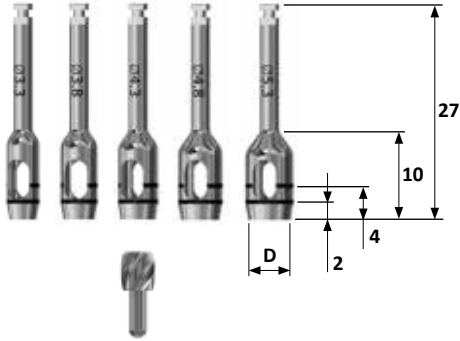

- Tool used for flapless surgery procedure
- Laser marking at 2mm interval, easily measures gingiva height
- Packing unit : Tissue punch + Guide pin
- Recommend using use tissue punch with a 0.7~1.5mm smaller diameter than the healing abutment

D	Ø3.3	Ø3.8	Ø4.3	Ø4.8	Ø5.3
Code	STP33	STP38	STP43	STP48	STP53

## Surgical Tap

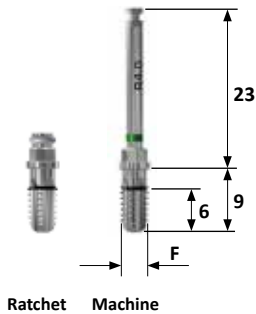

- For Only SEWONMEDIX IH2 Fixture
- Used in hard bone, it forms the thread shape of the fixture
- Use the torque wrench after installing a mount driver for ratchet
- When using the engine, Recommended speed : 25rpm
- Recommend tapping to the marking line lower
- F=Fixture

F \ Type	M3.5	R3.5	R4.0	R4.5	R5.0	R6.0
Machine	IHFTM35	IHFTM37	IHFTM40	IHFTM45	IHFTM50	IHFTM60
Ratchet	IHFTR35	IHFTR37	IHFTR40	IHFTR45	IHFTR50	IHFTR60

## Drilling sequence - Extra drill

Mini/Regular  $\varnothing 3.5\text{mm}$  Fixture (Length : 10.0mm)

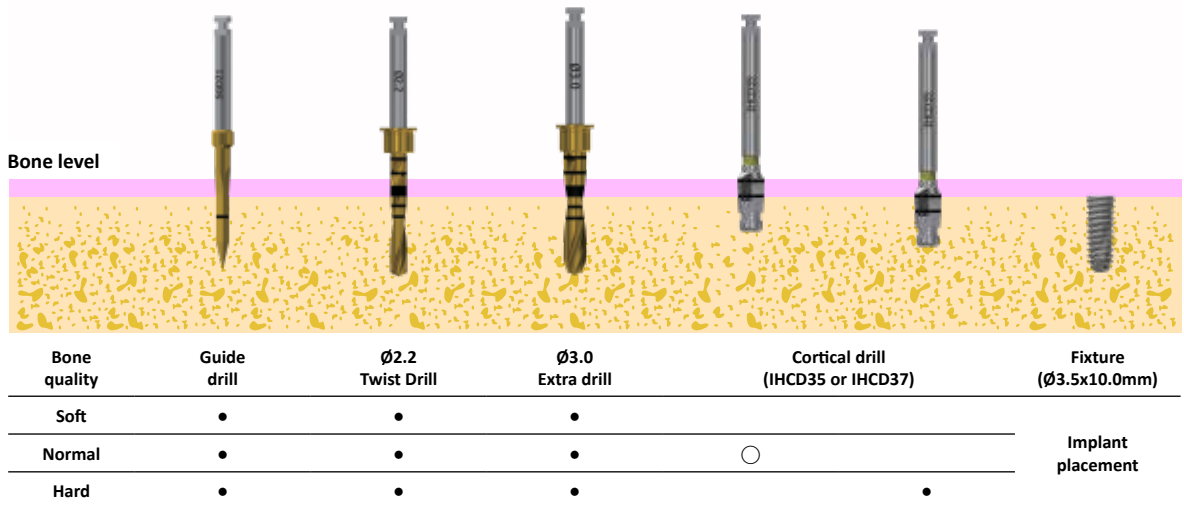

$\varnothing 4.0\text{mm}$  Fixture (Length : 10.0mm)

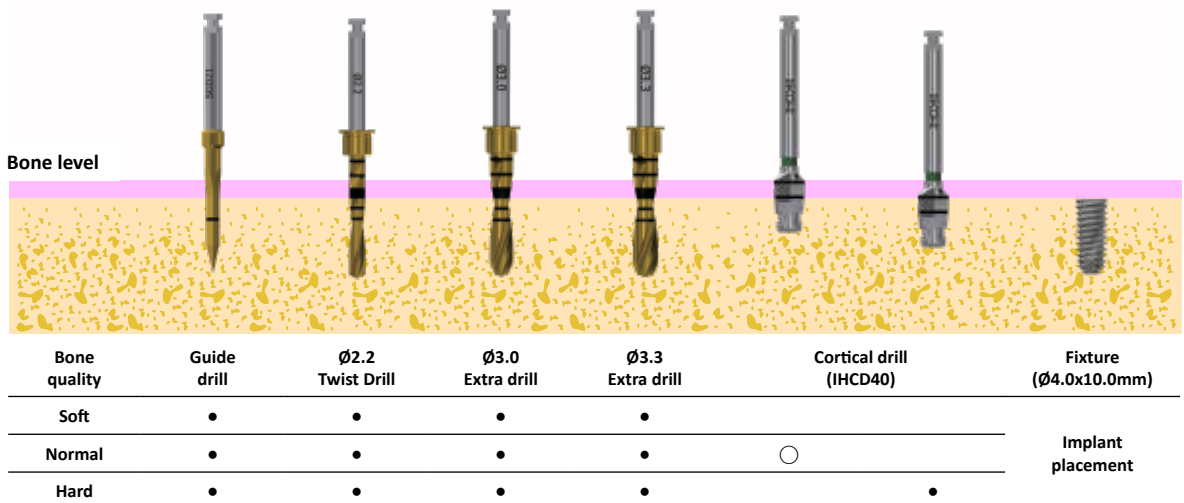

※ ○ : if necessary, use Cortical Drill

## Drilling sequence - Extra drill

Ø4.5mm Fixture (Length : 10.0mm)

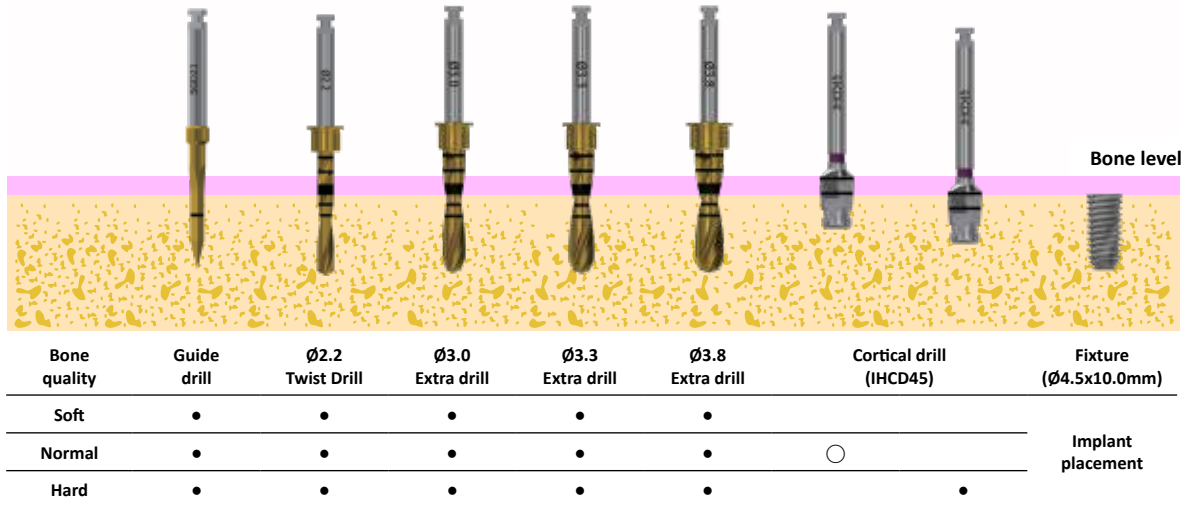

Ø5.0mm Fixture (Length : 10.0mm)

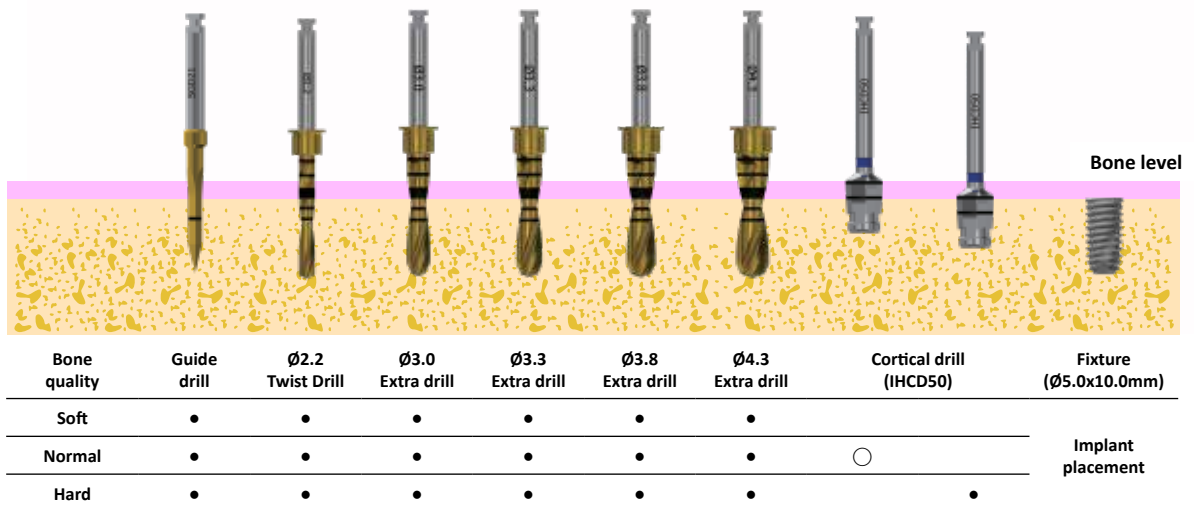

※ ○ : if necessary, use Cortical Drill

## Drilling sequence - Extra drill

Ø6.0mm Fixture (Length : 10.0mm)

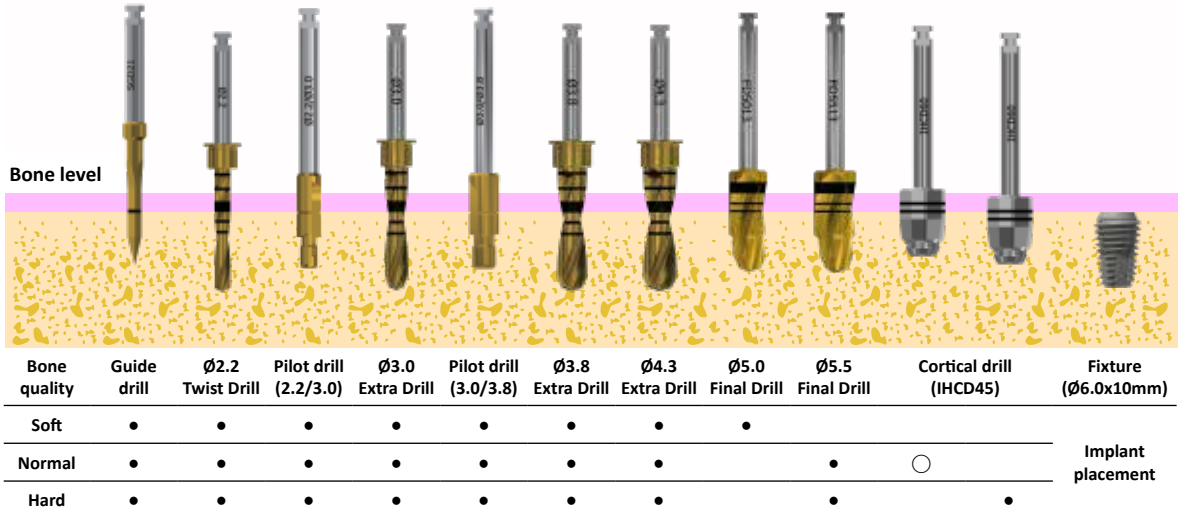

※ ○ : if necessary, use Cortical Drill



# Prosthetics Kit(PK5B)

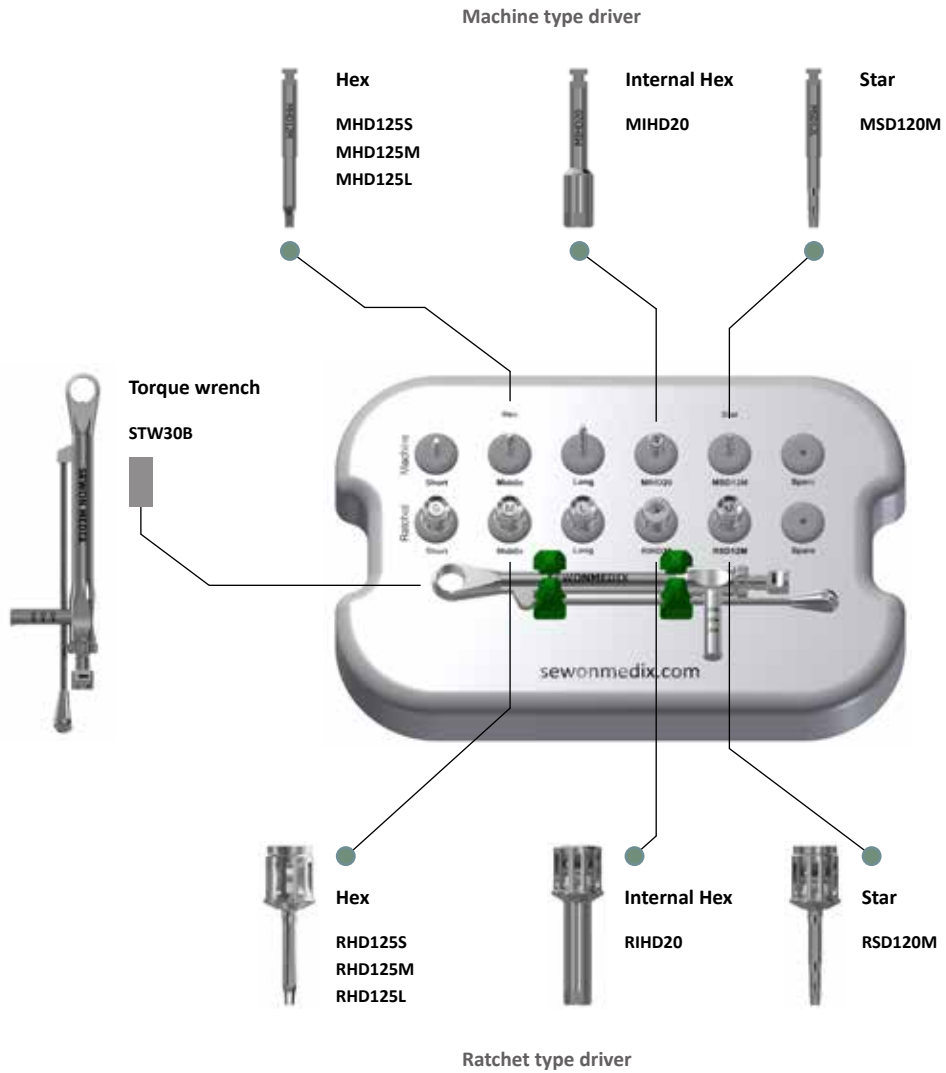

# Prosthetic Kit(PK125B)

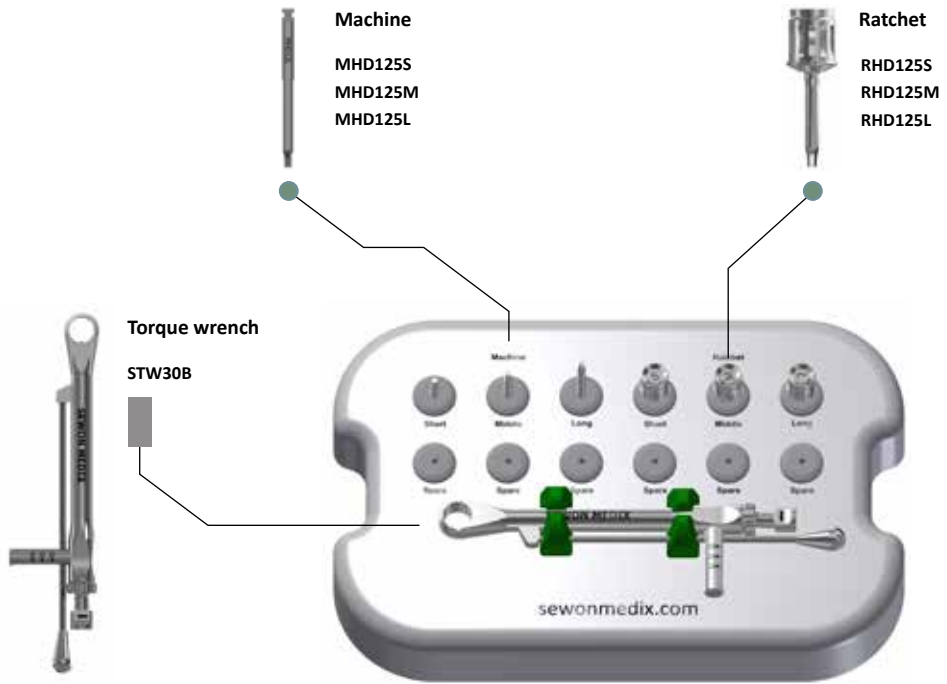

# Prosthetic Instruments

## Screw driver for Machine

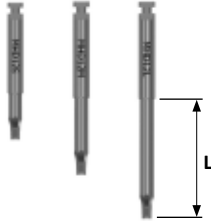

Type \ L	6.0mm	12.0mm	18.0mm
Hex 1.20	MHD120S	MHD120M	MHD120L
Hex 1.23	MHD123S	MHD123M	MHD123L
Hex 1.25	MHD125S	MHD125M	MHD125L
Hex 1.28	MHD128S	MHD128M	MHD128L
Star 1.20	MSD120S	MSD120M	MSD120L

## Screw driver for Machine - Ball type

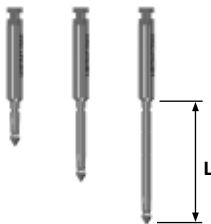

Type \ L	6.0mm	12.0mm	18.0mm
Hex 1.20	HBDM120S	HBDM120M	HBDM120L
Hex 1.23	HBDM123S	HBDM123M	HBDM123L
Hex 1.25	HBDM125S	HBDM125M	HBDM125L
Hex 1.28	HBDM128S	HBDM128M	HBDM128L
Star 1.20	SBDM120S	SBDM120M	SBDM120L

# Prosthetic Instruments

Screw driver for Ratchet



Type \ L	6.0mm	12.0mm	18.0mm
Hex 1.20	RHD120S	RHD120M	RHD120L
Hex 1.23	RHD123S	RHD123M	RHD123L
Hex 1.25	RHD125S	RHD125M	RHD125L
Hex 1.28	RHD128S	RHD128M	RHD128L
Star 1.20	RSD120S	RSD120M	RSD120L

Screw driver for Ratchet - Ball type

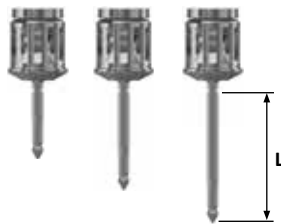

Type \ L	10.0mm	14.0mm	18.0mm
Hex 1.20	HBDR120S	HBDR120M	HBDR120L
Hex 1.23	HBDR123S	HBDR123M	HBDR123L
Hex 1.25	HBDR125S	HBDR125M	HBDR125L
Hex 1.28	HBDR128S	HBDR128M	HBDR128L
Star 1.20	SBDR120S	SBDR120M	SBDR120L

# Prosthetic Instruments

## Screw driver for Square



Type \ L	6.0mm	12.0mm	18.0mm
Hex 1.20	SHD120S	SHD120M	SHD120L
Hex 1.23	SHD123S	SHD123M	SHD123L
Hex 1.25	SHD125S	SHD125M	SHD125L
Hex 1.28	SHD128S	SHD128M	SHD128L
Star 1.20	SSD120S	SSD120M	SSD120L

## Screw driver for Square - Ball type

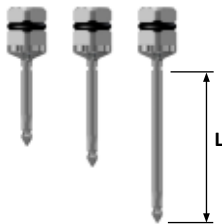

Type \ L	10.2mm	14.2mm	18.2mm
Hex 1.20	HBDS120S	HBDS120M	HBDS120L
Hex 1.23	HBDS123S	HBDS123M	HBDS123L
Hex 1.25	HBDS125S	HBDS125M	HBDS125L
Hex 1.28	HBDS128S	HBDS128M	HBDS128L
Star 1.20	SBDS120S	SBDS120M	SBDS120L

# Prosthetic Instruments

## Hand driver

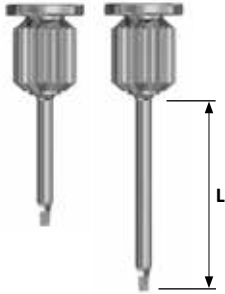

Type \ L	16.6mm	20.6mm	24.6mm
Hex 1.20	SDH120S	SDH120M	SDH120L
Hex 1.23	SDH123S	SDH123M	SDH123L
Hex 1.25	SDH125S	SDH125M	SDH125L
Hex 1.28	SDH128S	SDH128M	SDH28L
Star 1.20	SDHS120S	SDHS120M	SDHS120L

## Internal hex driver (for Multi-unit abutment)

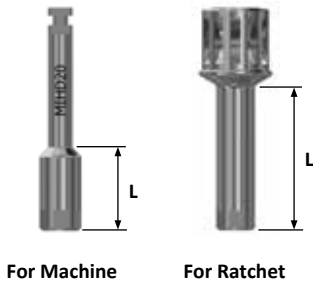

Type \ L	9.0mm	15.0mm
Machine	MIHD20S	MIHD20L
Ratchet	RIHD20S	RIHD20L

## Driver connector

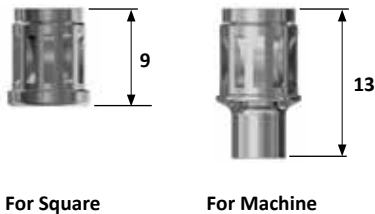

Type	For Square	For Machine
Code	DCS100	DCM120

For Square

For Machine

# IH SYSTEM

## PRODUCT CATALOG

PRODUCT CATALOG\_R6.2

11th January 2022



**Стоматорг – эксклюзивный дистрибьютор  
продукции Sewon Medix в России**

Офисно-складской комплекс

108814, г. Москва, пос. Сосенское,  
д. Николо-Хованское, д. 1017, стр.1.

Розничный отдел: [zakaz@stomatorg.ru](mailto:zakaz@stomatorg.ru) | +7(495) 620-97-34  
Оптовый отдел: [opt\\_dep@stomatorg.ru](mailto:opt_dep@stomatorg.ru) | +7(495) 620-97-32

| [www.stomatorg.ru](http://www.stomatorg.ru)  
[shop.stomatorg.ru](http://shop.stomatorg.ru)