



SEWON MEDIX IMPLANT SYSTEM

PRODUCT CATALOG



IH SYSTEM

PRODUCT CATALOG

Contents

IH SYSTEM		
	IH2 SLA Fixture	5
	Cover Screw / Mount	8
	Healing Abutment	9
Prosthetic Flow Diagram 1		
	Cement Abutment	13
	Angled Abutment	23
	FreeMilling Abutment	30
	CCM Casting Abutment	37
	Temporary Abutment	39
	Fixture Level Impression Coping / Analog	42
Prosthetic Flow Diagram 2		
	Multi-unit Abutment	53
	Multi-unit Abutment Components	57
Prosthetic Flow Diagram 3		
	LT Abutment	62
	BT Abutment	66
Etc.		
	Ti-Custom Block	70
	Ti-Base Abutment	74
Instruments		
	Surgical Kit	76
	SewonGuide Kit	89
	Expander Kit	93
	Prosthetic kit	95
Appendices		101

SEWON MEDIX IMPLANT SYSTEM



IH2 SLA Fixture

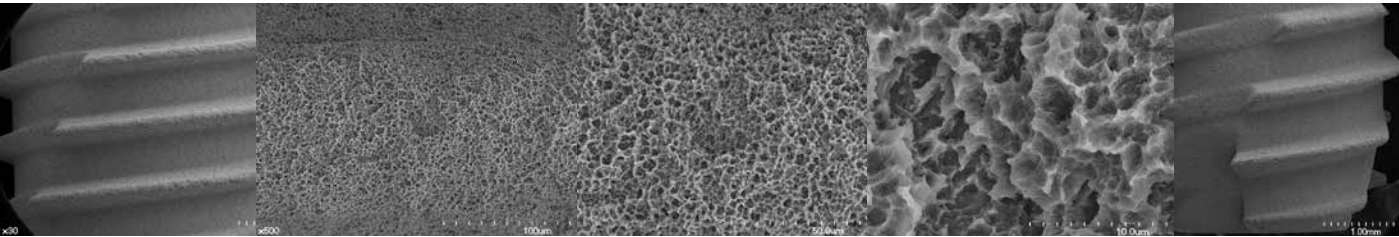

Feature of IH2 SLA Fixture

- Internal hex & 11° morse taper connected, submerged fixture
- SLA surface morphology and roughness increased by 45% compared to RBM treatment.
- SLA : Sandblasting with Large grits and Acid etching
 - Optimal surface roughness : Ra 2.5~3.0µm
- Taper body offers high initial stability
- Powerful Self threading
- Limited insertion torque : 40Ncm

We recommend that the fixture with over 4.5mm diameter is used for single case in molar.

IH2 SLA Fixture



URE



Mini Ø3.5

2.1

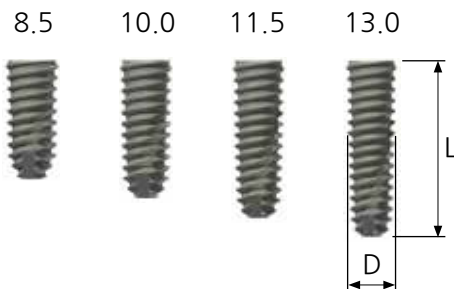

L	Mini Ø3.5
8.5	IH2FM3508S
10.0	IH2FM3510S
11.5	IH2FM3511S
13.0	IH2FM3513S



Regular Ø3.5

2.5

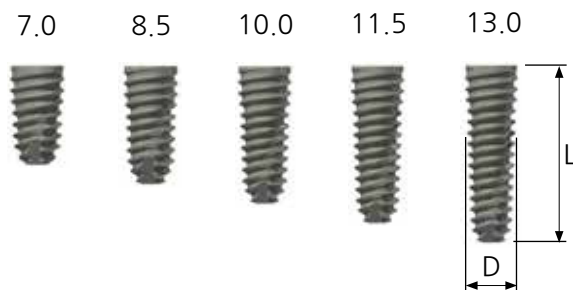

L	D	Regular Ø3.5
7.0		IH2FR3507S
8.5		IH2FR3508S
10.0		IH2FR3510S
11.5		IH2FR3511S
13.0		IH2FR3513S

Regular Ø4.0

2.5

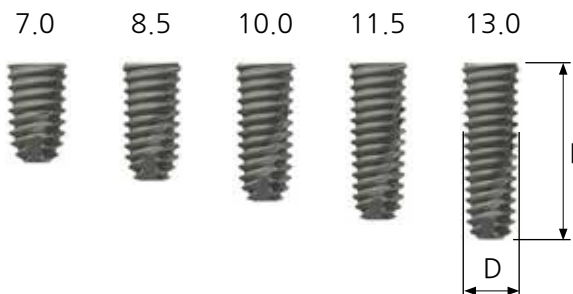

L	D	Regular Ø4.0
7.0		IH2FR4007S
8.5		IH2FR4008S
10.0		IH2FR4010S
11.5		IH2FR4011S
13.0		IH2FR4013S

- No-Mount fixture (Fixture + Cover screw) order code : **A**+Product code (ex : **AIH2FR3510S**)
- Pre-Mounted fixture (Fixture + Mount + Cover screw) order code : **B**+Product code (ex : **BIH2FR3510S**)

IH2 SLA Fixture



Regular Ø4.5

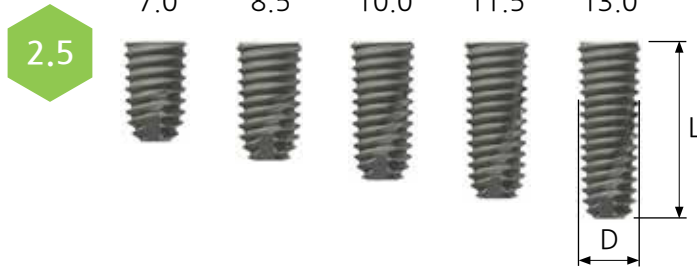

L \ D	Regular Ø4.5
7.0	IH2FR4507S
8.5	IH2FR4508S
10.0	IH2FR4510S
11.5	IH2FR4511S
13.0	IH2FR4513S

Regular Ø5.0

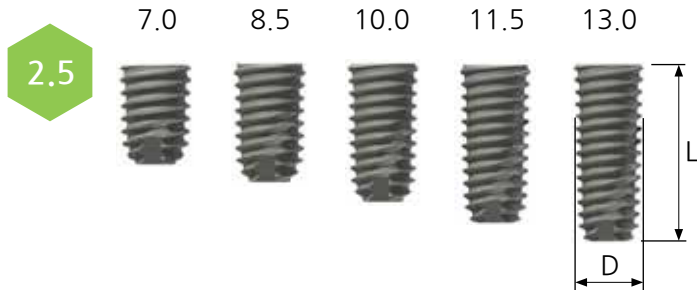

L \ D	Regular Ø5.0
7.0	IH2FR5007S
8.5	IH2FR5008S
10.0	IH2FR5010S
11.5	IH2FR5011S
13.0	IH2FR5013S

Regular Ø6.0

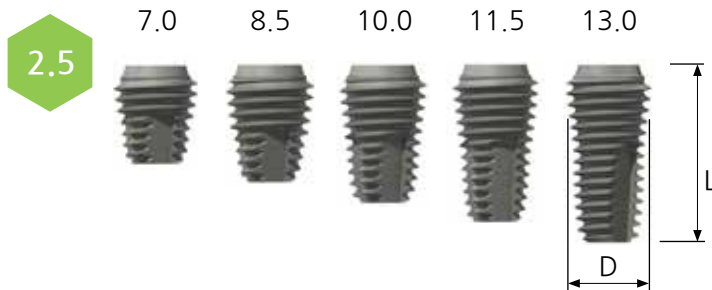

L \ D	Regular Ø6.0
7.0	IH2FR6007S
8.5	IH2FR6008S
10.0	IH2FR6010S
11.5	IH2FR6011S
13.0	IH2FR6013S

- No-Mount fixture (Fixture + Cover screw) order code : **A**+Product code (ex : **AIH2FR4510S**)
- Pre-Mounted fixture (Fixture + Mount + Cover screw) order code : **B**+Product code (ex : **BIH2FR4510S**)



Cover Screw



Fixture	Mini(Ø3.5)	Regular(Ø3.5)	Regular(Ø4.0~5.0)
Color	Purple	Blue	Green
Code	IHCSM	IHCSR32	IHCSR



- Tightening torque : 5~8Ncm
- Use the hex driver

Mount



Fixture	Mini(Ø3.5)	Regular(Ø3.5)	Regular(Ø4.0~5.0)
Color	Yellow	Blue	Green
Code	IHFMM35	IHFMR37	IHFMR40



- Tightening torque : 8~10Ncm
- Use the hex driver
- Single-use



Healing Abutment

Mini Ø4.0

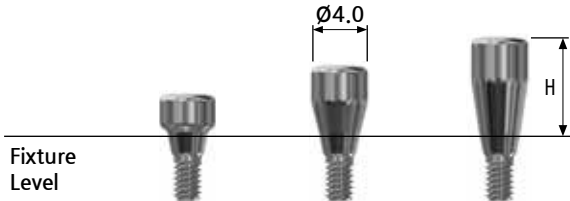

H \ D	Mini Ø4.0
3.0	IHHAM403
5.0	IHHAM405
7.0	IHHAM407

Mini Ø4.5

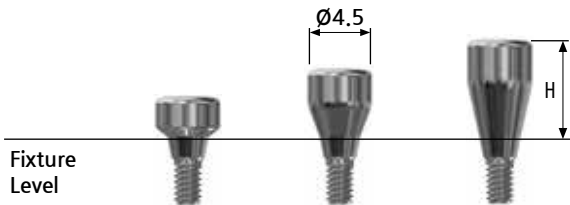

H \ D	Mini Ø4.5
3.0	IHHAM453
5.0	IHHAM455
7.0	IHHAM457

Regular Ø4.0

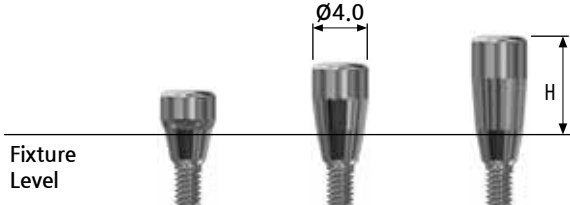

H \ D	Regular Ø4.0
3.0	IHHAR403
5.0	IHHAR405
7.0	IHHAR407

Regular Ø4.5

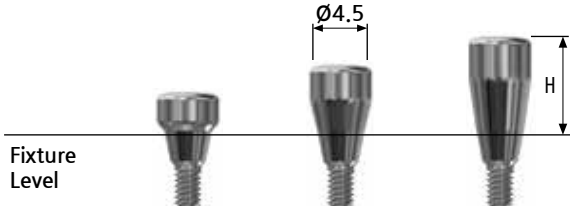

H \ D	Regular Ø4.5
3.0	IHHAR453
5.0	IHHAR455
7.0	IHHAR457

HEALING 

- Tightening torque : 5~8Ncm
- Use the hex driver



Healing Abutment

Regular Ø5.0

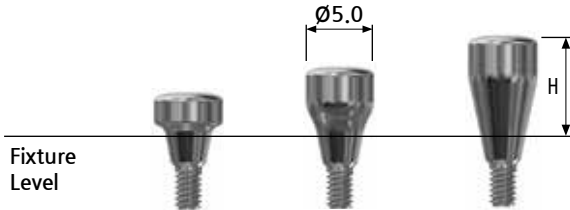

H \ D	Regular Ø5.0
3.0	IHHAR503
5.0	IHHAR505
7.0	IHHAR507

Regular Ø5.5

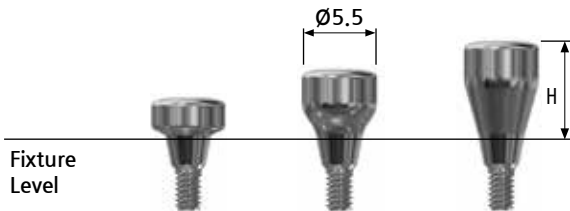

H \ D	Regular Ø5.5
3.0	IHHAR553
5.0	IHHAR555
7.0	IHHAR557

Regular Ø6.0

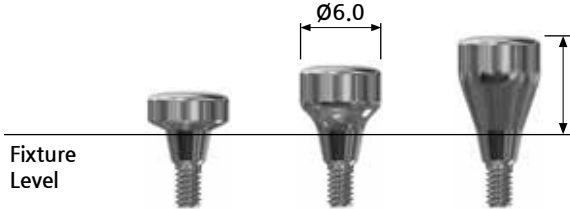

H \ D	Regular Ø6.0
3.0	IHHAR603
5.0	IHHAR605
7.0	IHHAR607

Regular Ø6.5

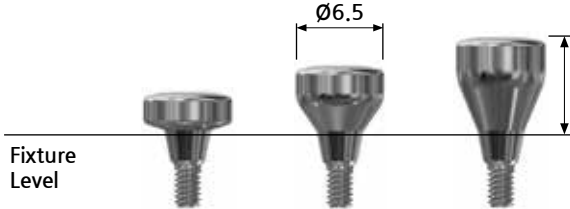

H \ D	Regular Ø6.5
3.0	IHHAR653
5.0	IHHAR655
7.0	IHHAR657

- Tightening torque : 5~8Ncm
- Use the hex driver

SEWON MEDIX IMPLANT SYSTEM



Prosthetic Flow Diagram 1

Cement Retained Restoration

Cement / Angled / FreeMilling / Temporary

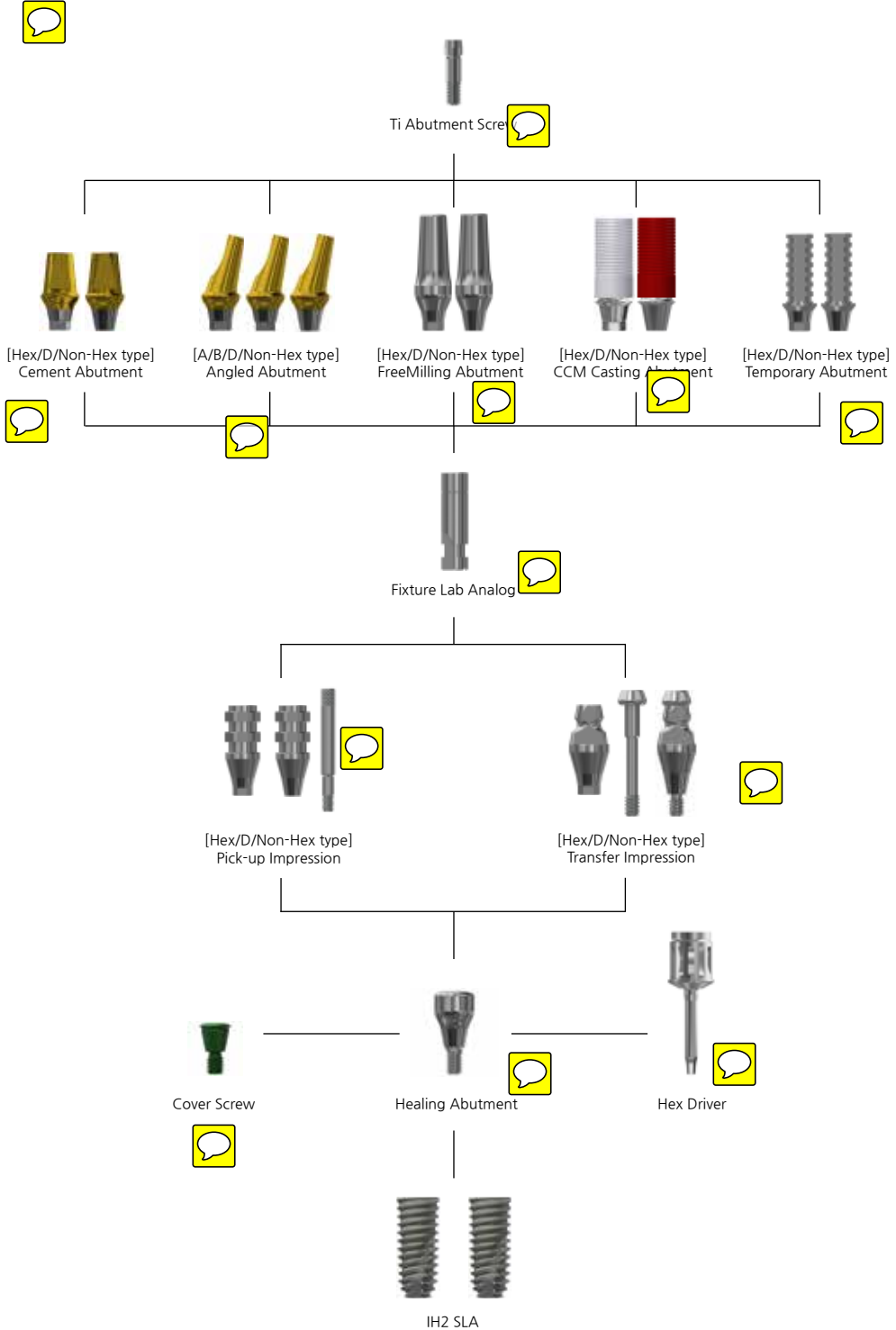

Cement Abutment(HEX TYPE)



- Use for making general cement-type prosthesis
- 11° taper connection for excellent safety
- Cross-section design for the prevention of prosthesis rotation
- Packing unit : Abutment + Ti-screw

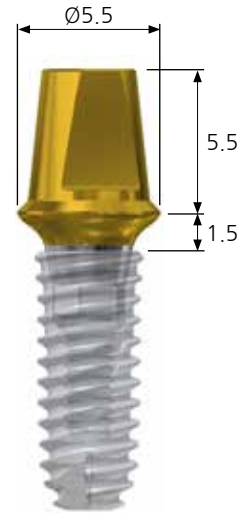

IHCARH5515M



CEMENT

S

D

N

Mini Ø4.5

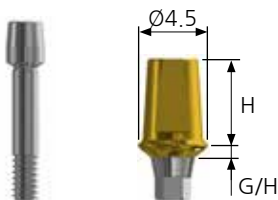

Mini Ø4.5			
G/H \ H	5.5	7.0	
1.0	IHCAMH4510M	IHCAMH4510L	
1.5	IHCAMH4515M	IHCAMH4515L	
2.0	IHCAMH4520M	IHCAMH4520L	
2.5	IHCAMH4525M	IHCAMH4525L	
3.0	IHCAMH4530M	IHCAMH4530L	
3.5	IHCAMH4535M	IHCAMH4535L	
4.0	IHCAMH4540M	IHCAMH4540L	

• Ti-Screw code : IHASM



- Abutment + Screw order code : A+Product code(ex : AIHCAMH4520MC)
- Tightening torque : 20Ncm • Use the hex driver



Cement Abutment(HEX TYPE)

Regular Ø4.5

CEMENT

S

D

N

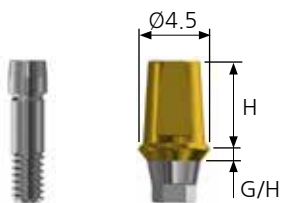

Regular Ø4.5		
G/H \ H	5.5	7.0
1.0	IHCARH4510M	IHCARH4510L
1.5	IHCARH4515M	IHCARH4515L
2.0	IHCARH4520M	IHCARH4520L
2.5	IHCARH4525M	IHCARH4525L
3.0	IHCARH4530M	IHCARH4530L
3.5	IHCARH4535M	IHCARH4535L
4.0	IHCARH4540M	IHCARH4540L

• Ti-Screw code : IHASR

Regular Ø5.0

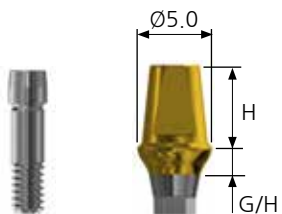

Regular Ø5.0		
G/H \ H	5.5	7.0
1.0	IHCARH5010M	IHCARH5010L
1.5	IHCARH5015M	IHCARH5015L
2.0	IHCARH5020M	IHCARH5020L
2.5	IHCARH5025M	IHCARH5025L
3.0	IHCARH5030M	IHCARH5030L
3.5	IHCARH5035M	IHCARH5035L
4.0	IHCARH5040M	IHCARH5040L

• Ti-Screw code : IHASR

- Abutment + Screw order code : A+Product code(ex : AIHCARH5020MC)
- Tightening torque : 30Ncm • Use the hex driver



Cement Abutment(HEX TYPE)

Regular Ø5.5

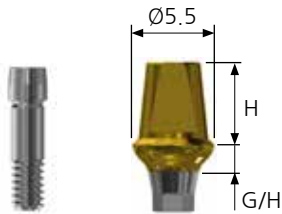

Regular Ø5.5			
G/H \ H	5.5	7.0	
1.0	IHCARH5510M	IHCARH5510L	
1.5	IHCARH5515M	IHCARH5515L	
2.0	IHCARH5520M	IHCARH5520L	
2.5	IHCARH5525M	IHCARH5525L	
3.0	IHCARH5530M	IHCARH5530L	
3.5	IHCARH5535M	IHCARH5535L	
4.0	IHCARH5540M	IHCARH5540L	

• Ti-Screw code : IHASR

Regular Ø6.0

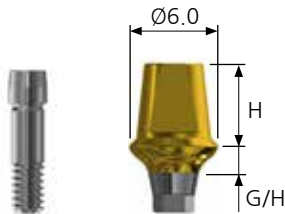

Regular Ø6.0			
G/H \ H	5.5	7.0	
1.0	IHCARH6010M	IHCARH6010L	
1.5	IHCARH6015M	IHCARH6015L	
2.0	IHCARH6020M	IHCARH6020L	
2.5	IHCARH6025M	IHCARH6025L	
3.0	IHCARH6030M	IHCARH6030L	
3.5	IHCARH6035M	IHCARH6035L	
4.0	IHCARH6040M	IHCARH6040L	

• Ti-Screw code : IHASR



- Abutment + Screw order code : **A**+Product code(ex : **AIHCARH5520MC**)
- Tightening torque : 30Ncm • Use the hex driver

Cement Abutment(HEX TYPE)

Regular Ø6.5



CEMENT

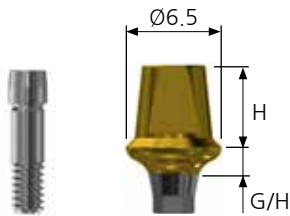

Regular Ø6.5		
G/H \ H	5.5	7.0
1.0	IHCARH6510M	IHCARH6510L
1.5	IHCARH6515M	IHCARH6515L
2.0	IHCARH6520M	IHCARH6520L
2.5	IHCARH6525M	IHCARH6525L
3.0	IHCARH6530M	IHCARH6530L
3.5	IHCARH6535M	IHCARH6535L
4.0	IHCARH6540M	IHCARH6540L

• Ti-Screw code : IHASR

- Abutment + Screw order code : **A**+Product code(ex : **AIHCARH6520MC**)
- Tightening torque : 30Ncm • Use the hex driver

Cement Abutment(HEX D-TYPE)



Regular Ø4.5

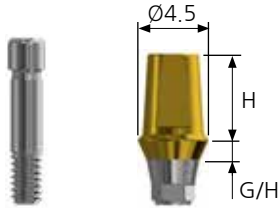

Regular Ø4.5		
G/H \ H	5.5	7.0
1.0	IHCARH4510MD	IHCARH4510LD
1.5	IHCARH4515MD	IHCARH4515LD
2.0	IHCARH4520MD	IHCARH4520LD
2.5	IHCARH4525MD	IHCARH4525LD
3.0	IHCARH4530MD	IHCARH4530LD
3.5	IHCARH4535MD	IHCARH4535LD
4.0	IHCARH4540MD	IHCARH4540LD

• Ti-Screw code : IHASD128

Regular Ø5.0

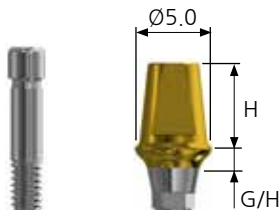

Regular Ø5.0		
G/H \ H	5.5	7.0
1.0	IHCARH5010MD	IHCARH5010LD
1.5	IHCARH5015MD	IHCARH5015LD
2.0	IHCARH5020MD	IHCARH5020LD
2.5	IHCARH5025MD	IHCARH5025LD
3.0	IHCARH5030MD	IHCARH5030LD
3.5	IHCARH5035MD	IHCARH5035LD
4.0	IHCARH5040MD	IHCARH5040LD

• Ti-Screw code : IHASD128

- Abutment + Screw order code : A+Product code(ex : AIHCARH5020MD)
- Tightening torque : 30Ncm • Use the hex driver

CEMENT

(S)

(D)

(N)

Cement Abutment(HEX D-TYPE)

Regular Ø5.5

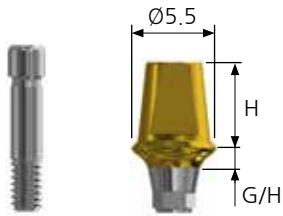

Regular Ø5.5		
G/H \ H	5.5	7.0
1.0	IHCARH5510MD	IHCARH5510LD
1.5	IHCARH5515MD	IHCARH5515LD
2.0	IHCARH5520MD	IHCARH5520LD
2.5	IHCARH5525MD	IHCARH5525LD
3.0	IHCARH5530MD	IHCARH5530LD
3.5	IHCARH5535MD	IHCARH5535LD
4.0	IHCARH5540MD	IHCARH5540LD

• Ti-Screw code : IHASD128

Regular Ø6.0

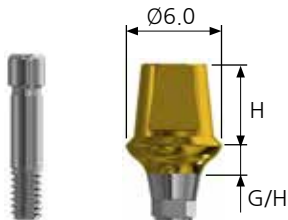

Regular Ø6.0		
G/H \ H	5.5	7.0
1.0	IHCARH6010MD	IHCARH6010LD
1.5	IHCARH6015MD	IHCARH6015LD
2.0	IHCARH6020MD	IHCARH6020LD
2.5	IHCARH6025MD	IHCARH6025LD
3.0	IHCARH6030MD	IHCARH6030LD
3.5	IHCARH6035MD	IHCARH6035LD
4.0	IHCARH6040MD	IHCARH6040LD

• Ti-Screw code : IHASD128

- Abutment + Screw order code : A+Product code(ex : AIHCARH5520MD)
- Tightening torque : 30Ncm • Use the hex driver

Cement Abutment(HEX D-TYPE)

Regular Ø6.5

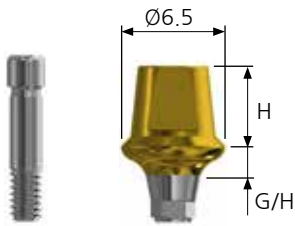

Regular Ø6.5			
G/H \ H	5.5	7.0	
1.0	IHCARH6510MD	IHCARH6510LD	
1.5	IHCARH6515MD	IHCARH6515LD	
2.0	IHCARH6520MD	IHCARH6520LD	
2.5	IHCARH6525MD	IHCARH6525LD	
3.0	IHCARH6530MD	IHCARH6530LD	
3.5	IHCARH6535MD	IHCARH6535LD	
4.0	IHCARH6540MD	IHCARH6540LD	

• Ti-Screw code : IHASD128

CEMENT

(S)

(D)

(N)

- Abutment + Screw order code : A+Product code(ex : AIHCARH6520MD)
- Tightening torque : 30Ncm • Use the hex driver

Cement Abutment(NON-HEX TYPE)

Mini Ø4.5

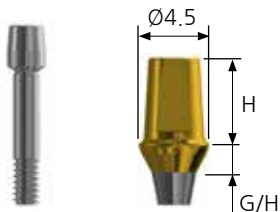

Mini Ø4.5		
G/H \ H	5.5	7.0
1.0	IHCAMN4510M	IHCAMN4510L
1.5	IHCAMN4515M	IHCAMN4515L
2.0	IHCAMN4520M	IHCAMN4520L
2.5	IHCAMN4525M	IHCAMN4525L
3.0	IHCAMN4530M	IHCAMN4530L
3.5	IHCAMN4535M	IHCAMN4535L
4.0	IHCAMN4540M	IHCAMN4540L

• Ti-Screw code : IHASM

Regular Ø4.5

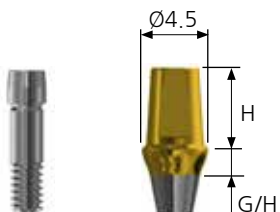

Regular Ø4.5		
G/H \ H	5.5	7.0
1.0	IHCARN4510M	IHCARN4510L
1.5	IHCARN4515M	IHCARN4515L
2.0	IHCARN4520M	IHCARN4520L
2.5	IHCARN4525M	IHCARN4525L
3.0	IHCARN4530M	IHCARN4530L
3.5	IHCARN4535M	IHCARN4535L
4.0	IHCARN4540M	IHCARN4540L

• Ti-Screw code : IHASR

- Abutment + Screw order code : A+Product code(ex : AIHCARN4520MC)
- Tightening torque : Mini-20Ncm, Regular-30Ncm
- Use the hex driver

Cement Abutment(NON-HEX TYPE)



Regular Ø5.0

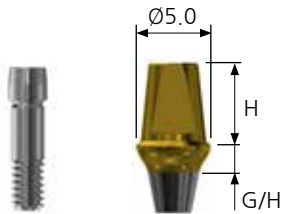

Regular Ø5.0		
G/H \ H	5.5	7.0
1.0	IHCARN5010M	IHCARN5010L
1.5	IHCARN5015M	IHCARN5015L
2.0	IHCARN5020M	IHCARN5020L
2.5	IHCARN5025M	IHCARN5025L
3.0	IHCARN5030M	IHCARN5030L
3.5	IHCARN5035M	IHCARN5035L
4.0	IHCARN5040M	IHCARN5040L

• Ti-Screw code : IHASR

Regular Ø5.5

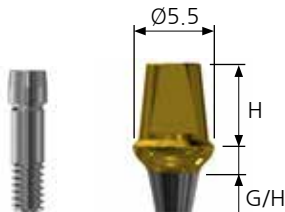

Regular Ø5.5		
G/H \ H	5.5	7.0
1.0	IHCARN5510M	IHCARN5510L
1.5	IHCARN5515M	IHCARN5515L
2.0	IHCARN5520M	IHCARN5520L
2.5	IHCARN5525M	IHCARN5525L
3.0	IHCARN5530M	IHCARN5530L
3.5	IHCARN5535M	IHCARN5535L
4.0	IHCARN5540M	IHCARN5540L

• Ti-Screw code : IHASR

CEMENT

(S)

(D)

(N)

- Abutment + Screw order code : A+Product code(ex : AIHCARN5520MC)
- Tightening torque : 30Ncm • Use the hex driver

Cement Abutment(NON-HEX TYPE)

Regular Ø6.0

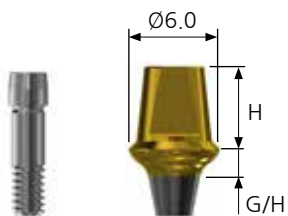

Regular Ø6.0		
G/H \ H	5.5	7.0
1.0	IHCARN6010M	IHCARN6010L
1.5	IHCARN6015M	IHCARN6015L
2.0	IHCARN6020M	IHCARN6020L
2.5	IHCARN6025M	IHCARN6025L
3.0	IHCARN6030M	IHCARN6030L
3.5	IHCARN6035M	IHCARN6035L
4.0	IHCARN6040M	IHCARN6040L

• Ti-Screw code : IHASR

Regular Ø6.5

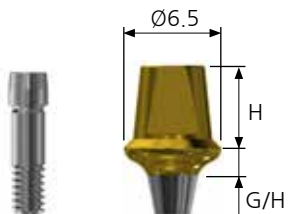

Regular Ø6.5		
G/H \ H	5.5	7.0
1.0	IHCARN6510M	IHCARN6510L
1.5	IHCARN6515M	IHCARN6515L
2.0	IHCARN6520M	IHCARN6520L
2.5	IHCARN6525M	IHCARN6525L
3.0	IHCARN6530M	IHCARN6530L
3.5	IHCARN6535M	IHCARN6535L
4.0	IHCARN6540M	IHCARN6540L

• Ti-Screw code : IHASR

- Abutment + Screw order code : A+Product code(ex : AIHCARN6520MC)
- Tightening torque : 30Ncm • Use the hex driver

Angled Abutment(HEX TYPE)



- Used for the path adjustment of prosthesis
- 11° taper connection for excellent safety
- Functions as a double hex type(A and B hex types)
- Packing unit : Abutment + Ti-screw

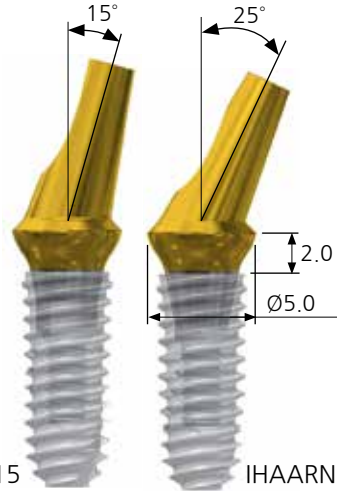

IHAARA502015

IHAARN502025

ANGLED

S

D

N

Mini Ø4.5

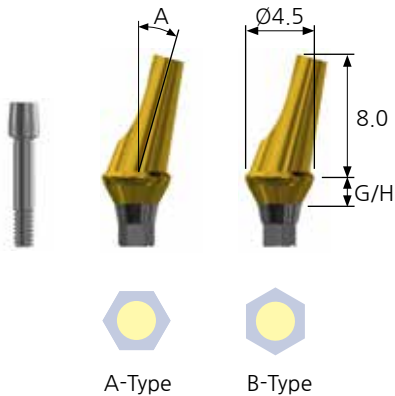

A-Type

B-Type

Mini Ø4.5			
Type	G/H \ A	15°	25°
		A	2.0
3.0	IHAAMA453015		IHAAMA453025
4.0	IHAAMA454015		IHAAMA454025
B	2.0	IHAAMB452015	IHAAMB452025
	3.0	IHAAMB453015	IHAAMB453025
	4.0	IHAAMB454015	IHAAMB454025

• Ti-Screw code : IHASM

- Abutment + Screw order code : A+Product code(ex : AIHAAMA452015C)
- Tightening torque : 20Ncm
- Use the hex driver



Angled Abutment(HEX TYPE)

Regular Ø4.5

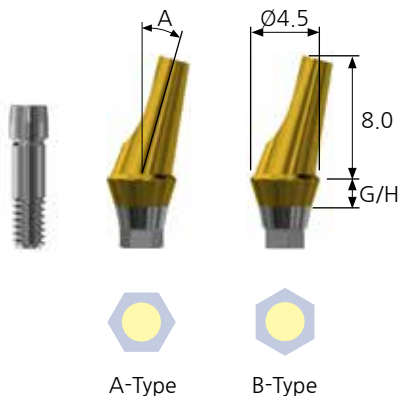

Regular Ø4.5			
Type	G/H \ A	15°	25°
		A	2.0
3.0	IHAARA453015		IHAARA453025
4.0	IHAARA454015		IHAARA454025
B	2.0	IHAARB452015	IHAARB452025
	3.0	IHAARB453015	IHAARB453025
	4.0	IHAARB454015	IHAARB454025

• Ti-Screw code : IHASR

Regular Ø5.0

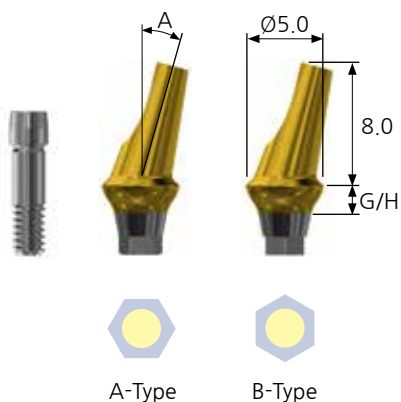

Regular Ø5.0			
Type	G/H \ A	15°	25°
		A	2.0
3.0	IHAARA503015		IHAARA503025
4.0	IHAARA504015		IHAARA504025
B	2.0	IHAARB502015	IHAARB502025
	3.0	IHAARB503015	IHAARB503025
	4.0	IHAARB504015	IHAARB504025

• Ti-Screw code : IHASR

- Abutment + Screw order code : A+Product code(ex : AIHAARA452015C)
- Tightening torque : 30Ncm • Use the hex driver

Angled Abutment(HEX TYPE)

Regular Ø5.5

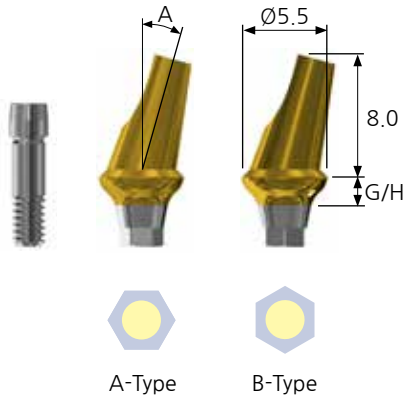

Regular Ø5.5			
Type	G/H	A	
		15°	25°
A	2.0	IHAARA552015	IHAARA552025
	3.0	IHAARA553015	IHAARA553025
	4.0	IHAARA554015	IHAARA554025
B	2.0	IHAARB552015	IHAARB552025
	3.0	IHAARB553015	IHAARB553025
	4.0	IHAARB554015	IHAARB554025

• Ti-Screw code : IHASR

Regular Ø6.0

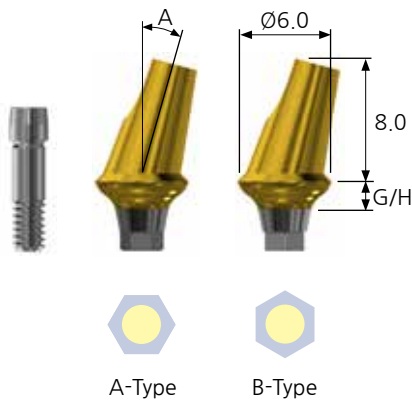

Regular Ø6.0			
Type	G/H	A	
		15°	25°
A	2.0	IHAARA602015	IHAARA602025
	3.0	IHAARA603015	IHAARA603025
	4.0	IHAARA604015	IHAARA604025
B	2.0	IHAARB602015	IHAARB602025
	3.0	IHAARB603015	IHAARB603025
	4.0	IHAARB604015	IHAARB604025

• Ti-Screw code : IHASR

- Abutment + Screw order code : A+Product code(ex : AIHAARA552015C)
- Tightening torque : 30Ncm • Use the hex driver

Angled Abutment(HEX D-TYPE)

Regular Ø4.5

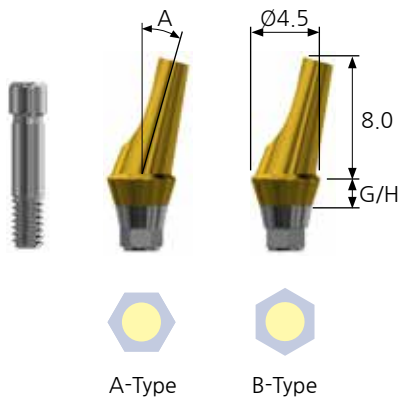

Regular Ø4.5			
Type	G/H \ A	15°	25°
		A	2.0
3.0	IHAARA453015D		IHAARA453025D
4.0	IHAARA454015D		IHAARA454025D
B	2.0	IHAARB452015D	IHAARB452025D
	3.0	IHAARB453015D	IHAARB453025D
	4.0	IHAARB454015D	IHAARB454025D

• Ti-Screw code : IHASD128

Regular Ø5.0

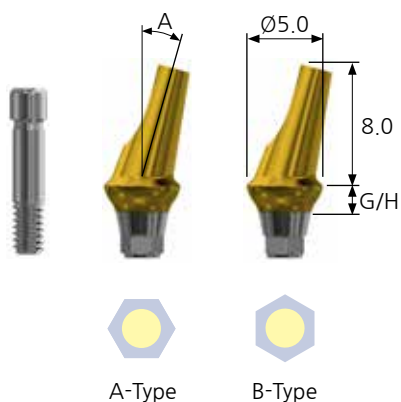

Regular Ø5.0			
Type	G/H \ A	15°	25°
		A	2.0
3.0	IHAARA503015D		IHAARA503025D
4.0	IHAARA504015D		IHAARA504025D
B	2.0	IHAARB502015D	IHAARB502025D
	3.0	IHAARB503015D	IHAARB503025D
	4.0	IHAARB504015D	IHAARB504025D

• Ti-Screw code : IHASD128

- Abutment + Screw order code : **A**+Product code(ex : **A**IHAARA452015D)
- Tightening torque : 30Ncm • Use the hex driver

Angled Abutment(HEX D-TYPE)

Regular Ø5.5

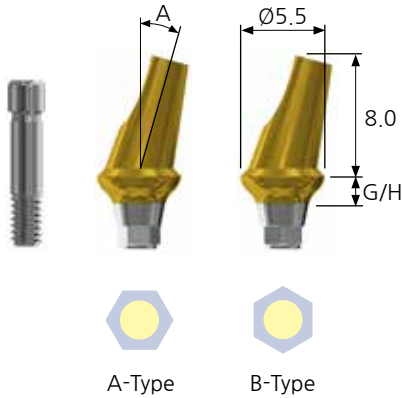

Regular Ø5.5			
Type	G/H \ A	15°	25°
		A	2.0
3.0	IHAARA553015D		IHAARA553025D
4.0	IHAARA554015D		IHAARA554025D
B	2.0	IHAARB552015D	IHAARB552025D
	3.0	IHAARB553015D	IHAARB553025D
	4.0	IHAARB554015D	IHAARB554025D

• Ti-Screw code : IHASD128

ANGLED
S
D
N

Regular Ø6.0

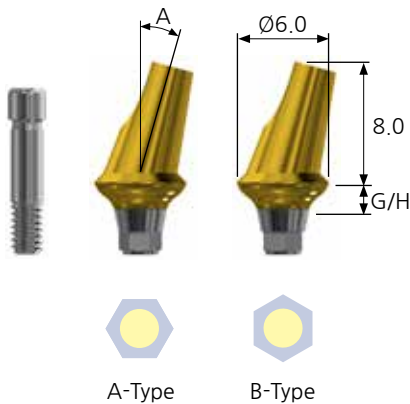

Regular Ø6.0			
Type	G/H \ A	15°	25°
		A	2.0
3.0	IHAARA603015D		IHAARA603025D
4.0	IHAARA604015D		IHAARA604025D
B	2.0	IHAARB602015D	IHAARB602025D
	3.0	IHAARB603015D	IHAARB603025D
	4.0	IHAARB604015D	IHAARB604025D

• Ti-Screw code : IHASD128

- Abutment + Screw order code : A+Product code(ex : AIHAARA552015D)
- Tightening torque : 30Ncm • Use the hex driver



Angled Abutment(NON-HEX TYPE)

Mini Ø4.5

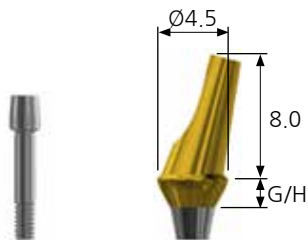

Mini Ø4.5		
G/H \ A	15°	25°
2.0	IHAAMN452015	IHAAMN452025
3.0	IHAAMN453015	IHAAMN453025
4.0	IHAAMN454015	IHAAMN454025

• Ti-Screw code : IHASM

Regular Ø4.5

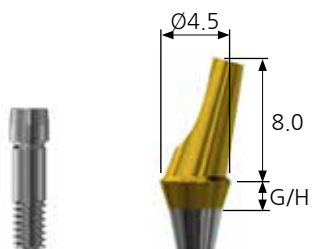

Regular Ø4.5		
G/H \ A	15°	25°
2.0	IHAARN452015	IHAARN452025
3.0	IHAARN453015	IHAARN453025
4.0	IHAARN454015	IHAARN454025

• Ti-Screw code : IHASR

Regular Ø5.0

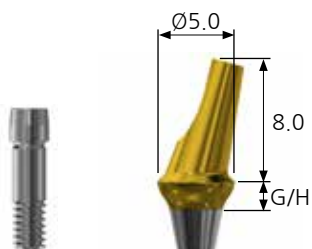

Regular Ø5.0		
G/H \ A	15°	25°
2.0	IHAARN502015	IHAARN502025
3.0	IHAARN503015	IHAARN503025
4.0	IHAARN504015	IHAARN504025

• Ti-Screw code : IHASR

- Abutment + Screw order code : A+Product code(ex : AIHAARN452015C)
- Tightening torque : Mini-20Ncm, Regular-30Ncm
- Use the hex driver

ANGLED

S

D

N

Angled Abutment(NON-HEX TYPE)

Regular Ø5.5

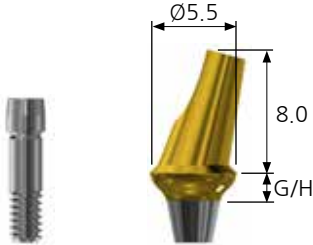

Regular Ø5.5		
G/H \ A	15°	25°
2.0	IHAARN552015	IHAARN552025
3.0	IHAARN553015	IHAARN553025
4.0	IHAARN554015	IHAARN554025

• Ti-Screw code : IHASR

Regular Ø6.0

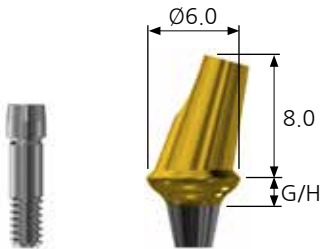

Regular Ø6.0		
G/H \ A	15°	25°
2.0	IHAARN602015	IHAARN602025
3.0	IHAARN603015	IHAARN603025
4.0	IHAARN604015	IHAARN604025

• Ti-Screw code : IHASR

ANGLED
S
D
N

- Abutment + Screw order code : A+Product code(ex : AIHAARN552015C)
- Tightening torque : 30Ncm • Use the hex driver

FreeMilling Abutment(HEX TYPE)

FREE
MILLING
S
D
N



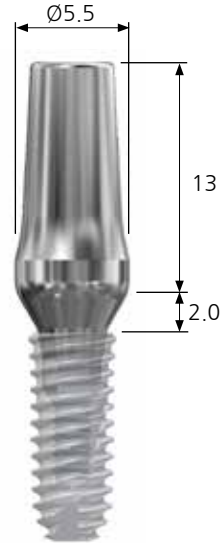

- Use for the path adjustment of abutments or customization of prosthetic margin
- 11° taper connection for excellent safety
- Packing unit : Abutment + Ti-screw

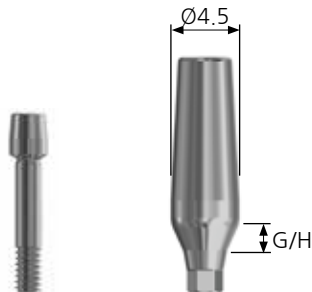

IHFMRH5520

Mini Ø4.5



Mini Ø4.5	
 G/H	Code 
1.0	IHFMMH4510
2.0	IHFMMH4520
3.0	IHFMMH4530

• Ti-Screw code : IHASM



- Abutment + Screw order code : **A**+Product code(ex : **AIHFMMH4520**)
- Tightening torque : 20Ncm • Use the hex driver



FreeMilling Abutment(HEX TYPE)

Regular Ø4.5

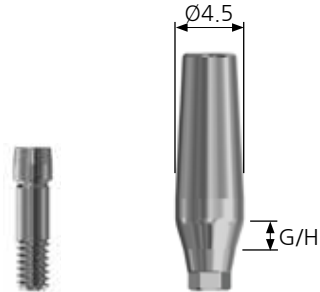

Regular Ø4.5	
G/H	Code
1.0	IHFMRH4510
2.0	IHFMRH4520
3.0	IHFMRH4530

• Ti-Screw code : IHASR

Regular Ø5.0

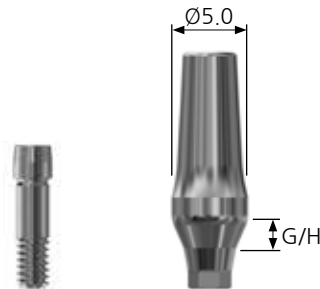

Regular Ø5.0	
G/H	Code
1.0	IHFMRH5010
2.0	IHFMRH5020
3.0	IHFMRH5030

• Ti-Screw code : IHASR

Regular Ø5.5

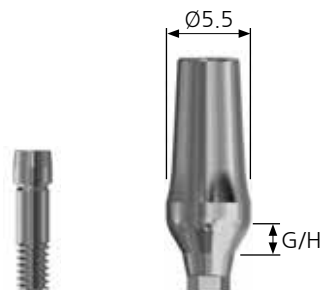

Regular Ø5.5	
G/H	Code
1.0	IHFMRH5510
2.0	IHFMRH5520
3.0	IHFMRH5530

• Ti-Screw code : IHASR

- Abutment + Screw order code : A+Product code(ex : AIHFMRH5020)
- Tightening torque : 30Ncm
- Use the hex driver

FreeMilling Abutment(HEX TYPE)

Regular Ø6.0

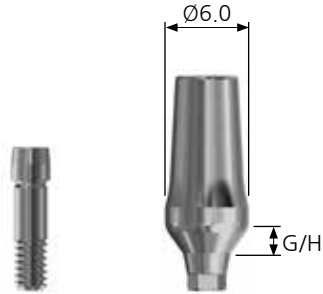

Regular Ø6.0	
G/H	Code
1.0	IHFMRH6010
2.0	IHFMRH6020
3.0	IHFMRH6030

• Ti-Screw code : IHASR

Regular Ø6.5

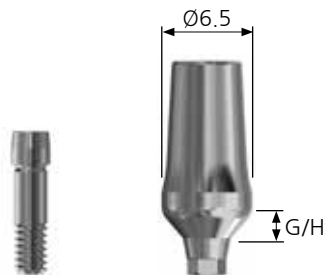

Regular Ø6.5	
G/H	Code
1.0	IHFMRH6510
2.0	IHFMRH6520
3.0	IHFMRH6530

• Ti-Screw code : IHASR

- Abutment + Screw order code : **A**+Product code(ex : **A**IHFMRH6020)
- Tightening torque : 30Ncm • Use the hex driver

FreeMilling Abutment(HEX D-TYPE)

Regular Ø4.5

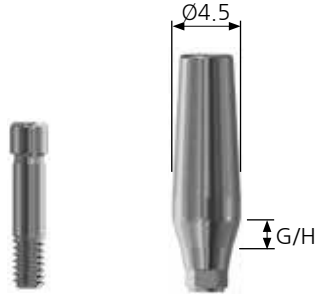

Regular Ø4.5	
G/H	Code
1.0	IHFMRH4510D
2.0	IHFMRH4520D
3.0	IHFMRH4530D

• Ti-Screw code : IHASD128

Regular Ø5.0

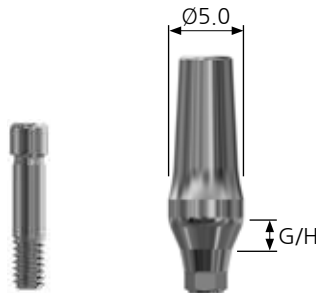

Regular Ø5.0	
G/H	Code
1.0	IHFMRH5010D
2.0	IHFMRH5020D
3.0	IHFMRH5030D

• Ti-Screw code : IHASD128

Regular Ø5.5

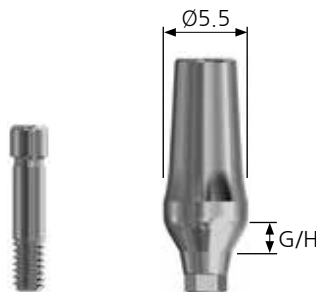

Regular Ø5.5	
G/H	Code
1.0	IHFMRH5510D
2.0	IHFMRH5520D
3.0	IHFMRH5530D

• Ti-Screw code : IHASD128

- Abutment + Screw order code : **A**+Product code(ex : **A**IHFMRH5020D)
- Tightening torque : 30Ncm • Use the hex driver

FreeMilling Abutment(HEX D-TYPE)

Regular Ø6.0

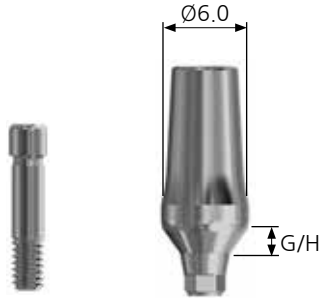

Regular Ø6.0	
G/H	Code
1.0	IHFMRH6010D
2.0	IHFMRH6020D
3.0	IHFMRH6030D

• Ti-Screw code : IHASD128

Regular Ø6.5

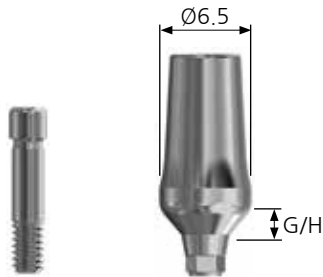

Regular Ø6.5	
G/H	Code
1.0	IHFMRH6510D
2.0	IHFMRH6520D
3.0	IHFMRH6530D

• Ti-Screw code : IHASD128

- Abutment + Screw order code : **A**+Product code(ex : **AIHFMRH6020D**)
- Tightening torque : 30Ncm • Use the hex driver

FreeMilling Abutment(NON-HEX TYPE)



Mini Ø4.5

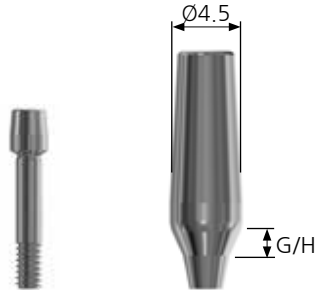

Mini Ø4.5	
G/H	Code
1.0	IHFMMN4510
2.0	IHFMMN4520
3.0	IHFMMN4530

• Ti-Screw code : IHASM

Regular Ø4.5

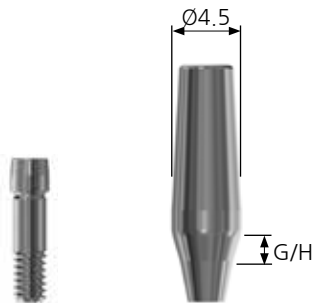

Regular Ø4.5	
G/H	Code
1.0	IHFMRN4510
2.0	IHFMRN4520
3.0	IHFMRN4530

• Ti-Screw code : IHASR

Regular Ø5.0

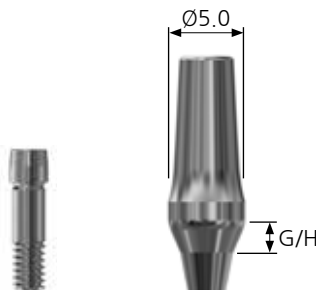

Regular Ø5.0	
G/H	Code
1.0	IHFMRN5010
2.0	IHFMRN5020
3.0	IHFMRN5030

• Ti-Screw code : IHASR

- Abutment + Screw order code : **A**+Product code(ex : **A**IHFMRN5020)
- Tightening torque : Mini-20Ncm, Regular-30Ncm
- Use the hex driver

FreeMilling Abutment(NON-HEX TYPE)

Regular Ø5.5

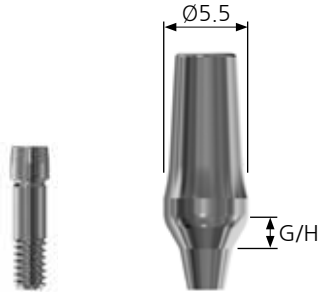

Regular Ø5.5	
G/H	Code
1.0	IHFMRN5510
2.0	IHFMRN5520
3.0	IHFMRN5530

• Ti-Screw code : IHASR

Regular Ø6.0

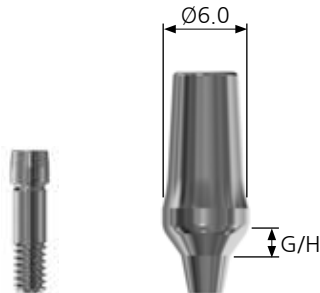

Regular Ø6.0	
G/H	Code
1.0	IHFMRN6010
2.0	IHFMRN6020
3.0	IHFMRN6030

• Ti-Screw code : IHASR

Regular Ø6.5

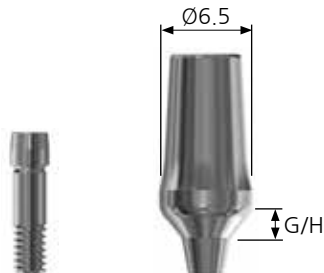

Regular Ø6.5	
G/H	Code
1.0	IHFMRN6510
2.0	IHFMRN6520
3.0	IHFMRN6530

• Ti-Screw code : IHASR

- Abutment + Screw order code : **A**+Product code(ex : **AIHFMRN6020**)
- Tightening torque : 30Ncm
- Use the hex driver

CCM Casting Abutment



- Used in producing screw-retained prosthetics
- Used when path, aesthetics, or space have limitations
- CCM casting abutment replaces expensive gold to alleviate financial burden to all.
- Abutment region fusion range : 1400°C~1550°C
- Packing unit : Abutment + Sleeve + Ti-screw



IHCCARH4510

CCM CASTING

S

D

N

Mini Ø4.0



Mini Ø4.0		
G/H	Hex	Non-Hex
1.0	IHCCAMH4010	IHCCAMN4010
3.0	IHCCAMH4030	IHCCAMN4030

• Ti-Screw code : IHASM



- Abutment + Screw order code : **A**+Product code(ex : **AIHCCAMH4010**)
- Tightening torque : 20Ncm • Use the hex driver



CCM Casting Abutment

Regular Ø4.5



Regular Ø4.5		
G/H	Hex	Non-Hex
1.0	IHCCARH4510	IHCCARN4510
3.0	IHCCARH4530	IHCCARN4530

• Ti-Screw code : IHASR

Regular D-type Ø4.5



Regular D-type Ø4.5	
G/H	Hex
1.0	IHCCARH4510D
3.0	IHCCARH4530D

• Ti-Screw code : IHASD128

- Abutment + Screw order code : **A**+Product code(ex : **AIHCCARH4510**)
- Tightening torque : 30Ncm • Use the hex driver

Temporary Abutment(HEX TYPE)



- Use to make temporary prosthesis
- 11° taper connection for excellent safety
- Packing unit : Abutment + Ti-screw

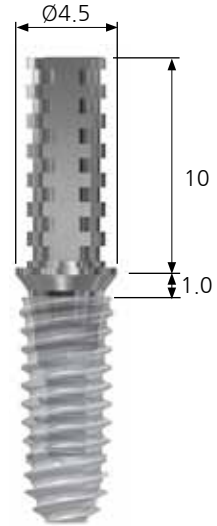

IHTARH4510

TEMPORARY
S
D
N

Mini Ø4.0

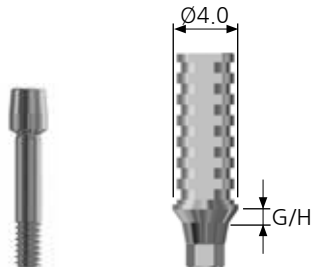

Mini Ø4.0	
G/H	Code
1.0	IHTAMH4010
3.0	IHTAMH4030

• Ti-Screw code : IHASM 

- Abutment + Screw order code : A+Product code(ex : AIHTAMH4010)
- Tightening torque : 20Ncm
- Use the hex driver



Temporary Abutment(HEX TYPE)

Regular Ø4.5

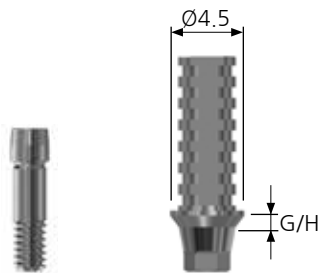

Regular Ø4.5	
G/H	Code
1.0	IHTARH4510
3.0	IHTARH4530

• Ti-Screw code : IHASR

Temporary Abutment(HEX D-TYPE)



Regular Ø4.5

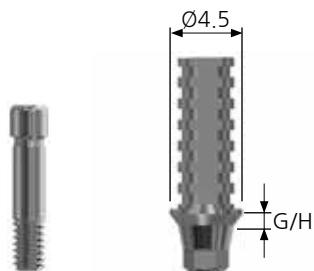

Regular Ø4.5	
G/H	Code
1.0	IHTARH4510D
3.0	IHTARH4530D

• Ti-Screw code : IHASD128

- Abutment + Screw order code : **A**+Product code(ex : **AIHTARH4510**)
- Tightening torque : 20Ncm • Use the hex driver

Temporary Abutment(NON-HEX TYPE)



Mini Ø4.0

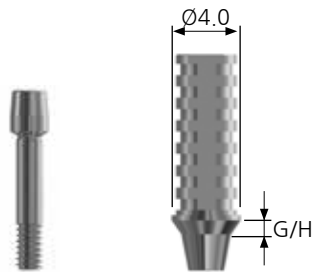

Mini Ø4.0	
G/H	Code
1.0	IHTAMN4010
3.0	IHTAMN4030

• Ti-Screw code : IHASM

TEMPORARY
S
D
N

Regular Ø4.5

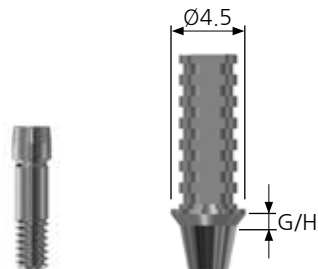

Regular Ø4.5	
G/H	Code
1.0	IHTARN4510
3.0	IHTARN4530

• Ti-Screw code : IHASR

- Abutment + Screw order code : A+Product code(ex : AIHTARN4510)
- Tightening torque : 20Ncm
- Use the hex driver

Fixture Level Impression Coping

Pick-up type



Mini Ø4.0 / Ø4.5

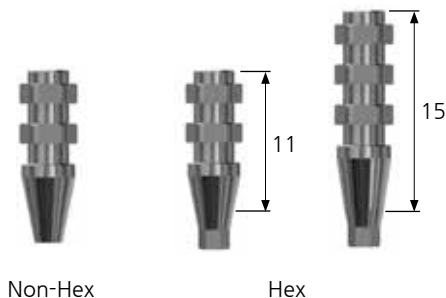

Mini Ø4.0/4.5		
L	Hex	Non-Hex
11	IHPIMH4011	IHPIMN4011
	IHPIMH4511	IHPIMN4511
15	IHPIMH4015	IHPIMN4015
	IHPIMH4515	IHPIMN4515

Guide Pin

Mini



Mini	
Size	Code
Short	IHPIGPM100
Middle	IHPIGPM150
Long	IHPIGPM150L



Regular



Regular		
Size	Code	
Short	IHPIGPR100	IHPIGPR100D
Middle	IHPIGPR150	IHPIGPR150D
Long	IHPIGPR150L	IHPIGPR150LD

- Pick-up type for taking an impression using a customized tray
- Packing unit : Impression body + Guide pin
- Use the hex driver



Fixture Level Impression Coping

Pick-up type

Regular Ø4.0

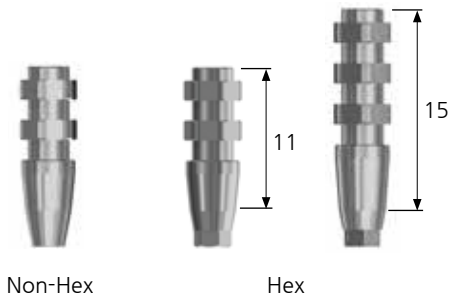

Regular Ø4.0		
L	Hex	Non-Hex
11	IHPIRH4011	IHPIRN4011
15	IHPIRH4015	IHPIRN4015

Regular Ø4.5

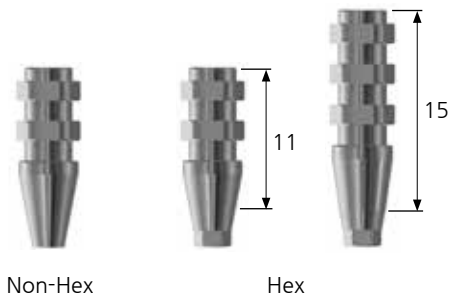

Regular Ø4.5		
L	Hex	Non-Hex
11	IHPIRH4511	IHPIRN4511
15	IHPIRH4515	IHPIRN4515

Regular Ø5.0

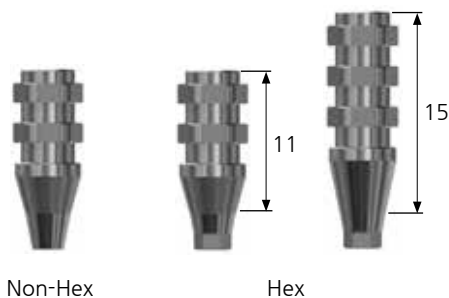

Regular Ø5.0		
L	Hex	Non-Hex
11	IHPIRH5011	IHPIRN5011
15	IHPIRH5015	IHPIRN5015

- Pick-up type for taking an impression using a customized tray
- Packing unit : Impression body + Guide pin
- Use the hex driver

Fixture Level Impression Coping

Pick-up type

Regular Ø5.5

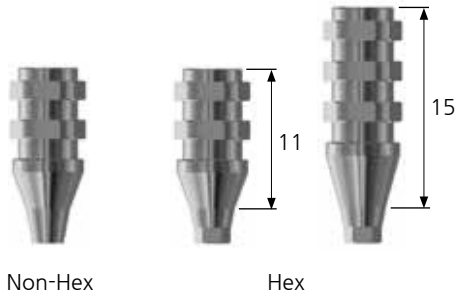

Regular Ø5.5		
L	Hex	Non-Hex
11	IHPIRH5511	IHPIRN5511
15	IHPIRH5515	IHPIRN5515

Regular Ø6.0

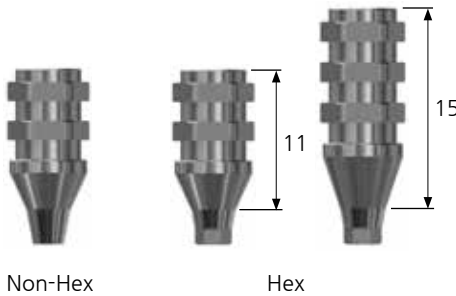

Regular Ø6.0		
L	Hex	Non-Hex
11	IHPIRH6011	IHPIRN6011
15	IHPIRH6015	IHPIRN6015

- Pick-up type for taking an impression using a customized tray
- Packing unit : Impression body + Guide pin
- Use the hex driver

IMPRESSION
S
D
N

Fixture Level Impression Coping (HEX D-TYPE) Pick-up type

Regular Ø4.0

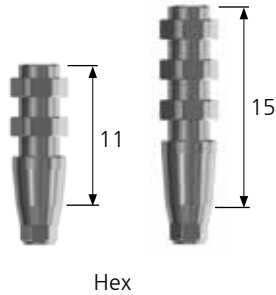

Regular Ø4.0	
L	Hex D-type
11	IHPIRH4011D
15	IHPIRH4015D

Regular Ø4.5

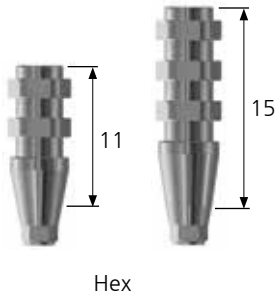

Regular Ø4.5	
L	Hex D-type
11	IHPIRH4511D
15	IHPIRH4515D

Regular Ø5.0

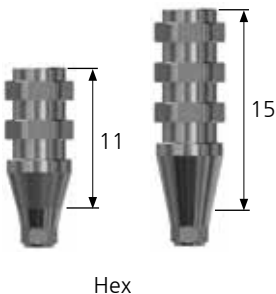

Regular Ø5.0	
L	Hex D-type
11	IHPIRH5011D
15	IHPIRH5015D

IMPRESSION
S
D
N

- Pick-up type for taking an impression using a customized tray
- Packing unit : Impression body + Guide pin
- Use the hex driver

Fixture Level Impression Coping (HEX D-TYPE) Pick-up type

Regular Ø5.5

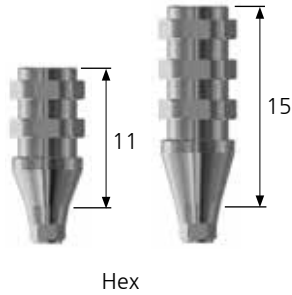

Regular Ø5.5	
L	Hex D-type
11	IHPIRH5511D
15	IHPIRH5515D

Regular Ø6.0

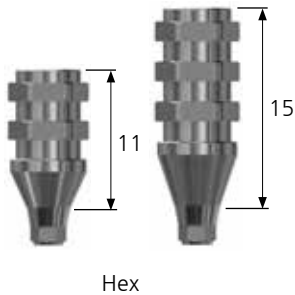

Regular Ø6.0	
L	Hex D-type
11	IHPIRH6011D
15	IHPIRH6015D

- Pick-up type for taking an impression using a customized tray
- Packing unit : Impression body + Guide pin
- Use the hex driver

Fixture Lab Analog

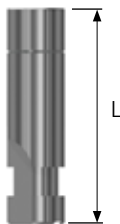

L	Mini	Regular		D-TYPE
12	IHFLAM120	IHFLAR350	IHFLAR120	IHFLAR120D
15	IHFLAM150	IHFLAR350L	IHFLAR150	IHFLAR150D

Fixture Level Impression Coping

Transfer type



Mini Ø4.0 / Ø4.5



Non-Hex

Hex

Mini Ø4.0		
L	Hex	Non-Hex
11	IHTIMH4011	IHTIMN4011
	IHTIMH4511	IHTIMN4511
14	IHTIMH4014	IHTIMN4014
	IHTIMH4514	IHTIMN4514

Regular Ø4.0



Non-Hex

Hex

Regular Ø4.0		
L	Hex	Non-Hex
11	IHTIRH4011	IHTIRN4011
14	IHTIRH4014	IHTIRN4014

Regular Ø4.5



Non-Hex

Hex

Regular Ø4.5		
L	Hex	Non-Hex
11	IHTIRH4511	IHTIRN4511
14	IHTIRH4514	IHTIRN4514

IMPRESSION

S

D

N

- Transfer type for taking an impression using a ready-made tray
- Packing unit : Hex type = Impression coping + Guide pin
Non-Hex type = Impression coping
- Use the hex driver



Fixture Level Impression Coping

Transfer type

Regular Ø5.0



Regular Ø5.0		
L	Hex	Non-Hex
11	IHTIRH5011	IHTIRN5011
14	IHTIRH5014	IHTIRN5014

Regular Ø5.5

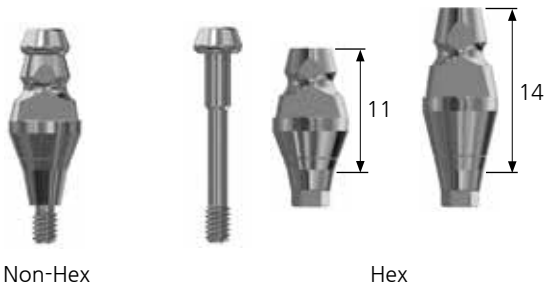

Regular Ø5.5		
L	Hex	Non-Hex
11	IHTIRH5511	IHTIRN5511
14	IHTIRH5514	IHTIRN5514

Regular Ø6.0



Regular Ø6.0		
L	Hex	Non-Hex
11	IHTIRH6011	IHTIRN6011
14	IHTIRH6014	IHTIRN6014

- Transfer type for taking an impression using a ready-made tray
- Packing unit : Hex type = Impression coping + Guide pin
Non-Hex type = Impression coping
- Use the hex driver

Fixture Level Impression Coping(HEX D-TYPE)

Transfer type



Regular Ø4.0

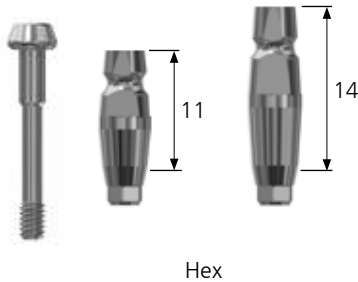

Hex

Regular Ø4.0	
L	Hex D-type
11	IHTIRH4011D
14	IHTIRH4014D

Regular Ø4.5

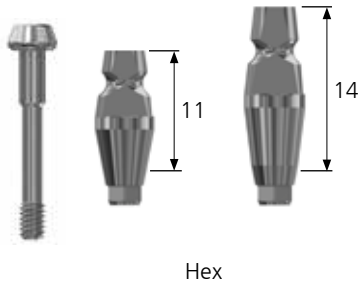

Hex

Regular Ø4.5	
L	Hex D-type
11	IHTIRH4511D
14	IHTIRH4514D

Regular Ø5.0

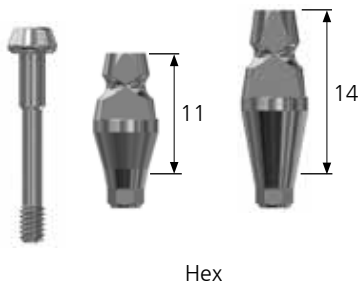

Hex

Regular Ø5.0	
L	Hex D-type
11	IHTIRH5011D
14	IHTIRH5014D

- Transfer type for taking an impression using a ready-made tray
- Packing unit : Hex type = Impression coping + Guide pin
- Use the hex driver

Fixture Level Impression Coping (HEX D-TYPE) Transfer type

Regular $\varnothing 5.5$

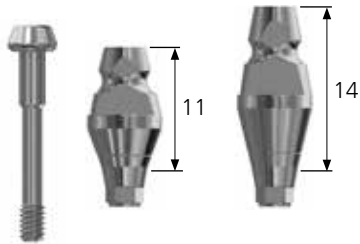

Hex

Regular $\varnothing 5.5$	
L	Hex D-type
11	IHTIRH5511D
14	IHTIRH5514D

Regular $\varnothing 6.0$

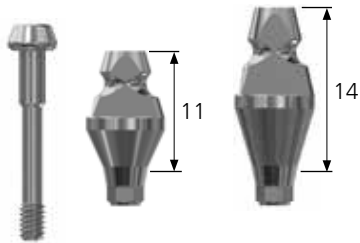

Hex

Regular $\varnothing 6.0$	
L	Hex D-type
11	IHTIRH6011D
14	IHTIRH6014D



IMPRESSION



- Transfer type for taking an impression using a ready-made tray
- Packing unit : Hex type = Impression coping + Guide pin
- Use the hex driver

SEWON MEDIX IMPLANT SYSTEM



Prosthetic Flow Diagram 2

Screw Retained Restoration

Multi-unit Abutment

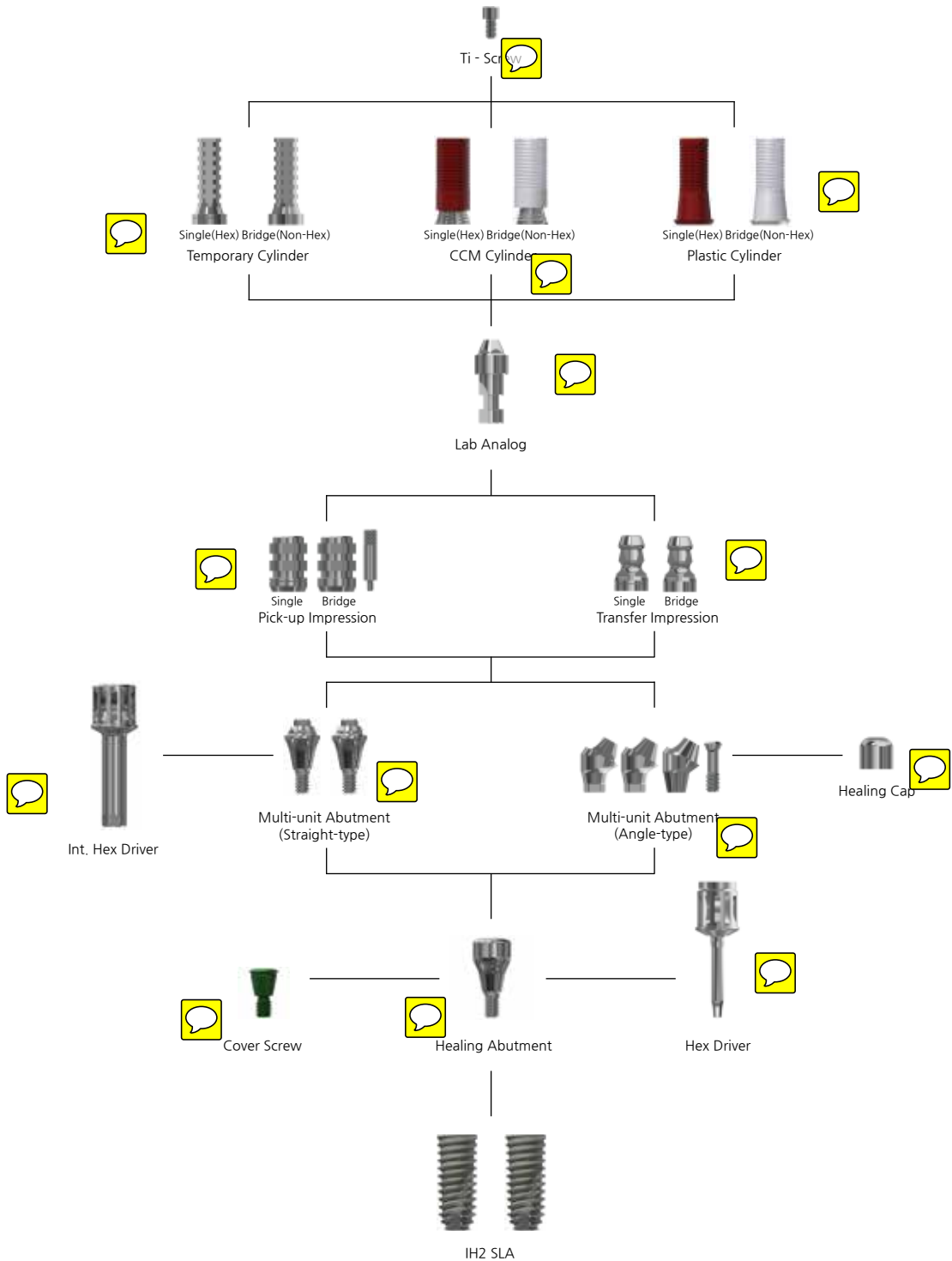

Multi-unit Abutment



- Use for screw-retained multiple cases.
- 11° taper connection for excellent safety
- Packing unit :
 Straight type = Abutment + Holder
 17°/30° type = Abutment + Ti screw + Holder



Straight type



Mini



Mini		
G/H	Bridge	Single
1.5	IHMAM15	IHMAM15S
2.5	IHMAM25	IHMAM25S
3.5	IHMAM35	IHMAM35S
4.5	IHMAM45	IHMAM45S

Regular



Regular		
G/H	Bridge	Single
1.5	IHMAR15	IHMAR15S
2.5	IHMAR25	IHMAR25S
3.5	IHMAR35	IHMAR35S
4.5	IHMAR45	IHMAR45S

- Abutment + Holder order code : **A**+Product code(ex : **AIHMAR25**)
- Tightening torque : 30Ncm
- Use the internal hex driver



Multi-unit Abutment

Mini

17° Multi-unit Abutment

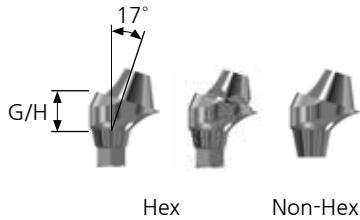

Mini 17° Multi-unit Abutment			
Fixture	Hex		Non-Hex
Cylinder	Bridge	Single	Bridge
2.5	IHMAMH2517	IHMAMH2517S	IHMAMN2517
3.0	IHMAMH3017	IHMAMH3017S	IHMAMN3017
4.0	IHMAMH4017	IHMAMH4017S	IHMAMN4017

• Ti-Screw code : IHMASM200



MULTI-UNIT

30° Multi-unit Abutment

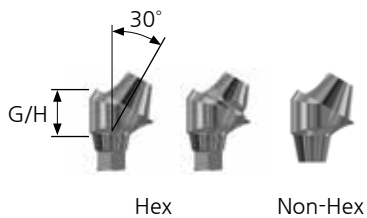

Mini 30° Multi-unit Abutment			
Fixture	Hex		Non-Hex
Cylinder	Bridge	Single	Bridge
3.5	IHMAMH3530	IHMAMH3530S	IHMAMN3530
4.0	IHMAMH4030	IHMAMH4030S	IHMAMN4030
5.0	IHMAMH5030	IHMAMH5030S	IHMAMN5030

• Ti-Screw code : IHMASM200



- Order code : A+Product code(ex : AIHMAMH3517)
- Tightening torque : 30Ncm
- Use the hex driver

Multi-unit Abutment

Regular

17° Multi-unit Abutment

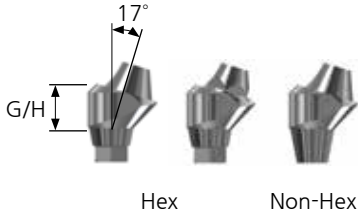

Regular 17° Multi-unit Abutment			
Fixture	Hex		Non-Hex
Cylinder	Bridge	Single	Bridge
2.5	IHMARH2517	IHMARH2517S	IHMARN2517
3.0	IHMARH3017	IHMARH3017S	IHMARN3017
4.0	IHMARH4017	IHMARH4017S	IHMARN4017

• Ti-Screw code : IHMASR200

30° Multi-unit Abutment

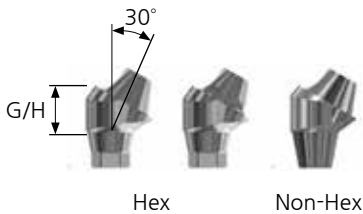

Regular 30° Multi-unit Abutment			
Fixture	Hex		Non-Hex
Cylinder	Bridge	Single	Bridge
3.5	IHMARH3530	IHMARH3530S	IHMARN3530
4.0	IHMARH4030	IHMARH4030S	IHMARN4030
5.0	IHMARH5030	IHMARH5030S	IHMARN5030

• Ti-Screw code : IHMASR200

- Order code : A+Product code(ex : AIHMARH3517)
- Tightening torque : 30Ncm
- Use the hex driver

Multi-unit Abutment(D-TYPE)

17° Multi-unit Abutment

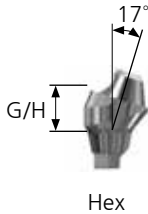

17° Multi-unit Abutment D-type	
G/H	Hex D-type
2.5	IHMARH2517D
3.5	IHMARH3517D

• Ti-Screw code : MARSD200

MULTI-UNIT

30° Multi-unit Abutment

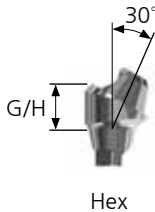

30° Multi-unit Abutment D-type	
G/H	Hex D-type
3.5	IHMARH3530D
4.5	IHMARH4530D

• Ti-Screw code : MARSD200

- Order code : A+Product code(ex : AIHMARH3517D)
- Tightening torque : 30Ncm
- Use the hex driver





Multi-unit Abutment Components

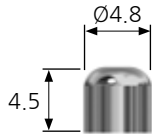

Healing Cap



Code	
MHC480H	

- Use the hex driver 
- Tightening torque : 20Ncm
- Packing unit : Healing cap

CCM Cylinder

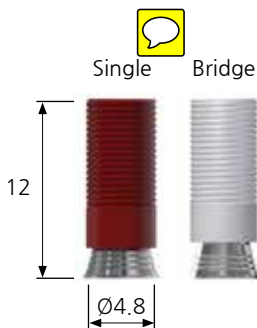

Screw	Bridge(Non-Hex)	Single(Hex)
CS200	MCC100H	MCC200H

- Use the hex driver 
- Tightening torque : 20Ncm
- Packing unit : Cylinder + Sleeve + Screw
- The prosthesis is made of alloy casting
- Cylinder + screw order code : A+Product code(ex : AMCC100H)

Multi-unit Abutment Components

Plastic Cylinder

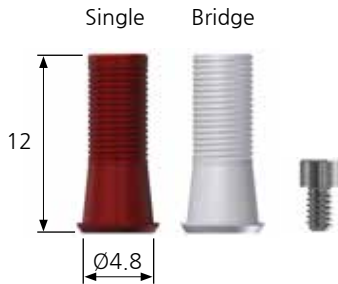

Screw	Bridge(Non-Hex)	Single(Hex)
CS200	MPC100H	MPC200H

- Use the hex driver
- Tightening torque : 20Ncm
- Packing unit : Cylinder + Screw
- The prosthesis is made of alloy casting
- Cylinder + screw order code : A+Product code(ex : AMPC100H)

Temporary Cylinder

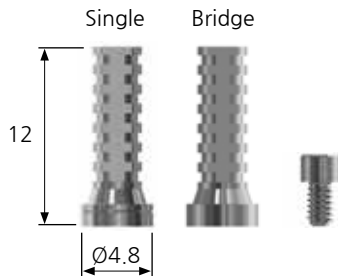

Screw	Bridge(Non-Hex)	Single(Hex)
CS200	MTC100H	MTC200H

- Use the hex driver 
- Tightening torque : 20Ncm
- Packing unit : Cylinder + Screw
- Multi-unit abutment used in the making of a temporary prosthesis
- Cylinder + screw order code : A+Product code(ex : AMTC100H)

Multi-unit Abutment Components

Transfer Impression Coping

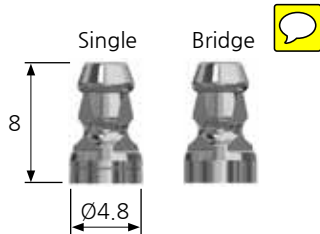

Screw	Bridge(Non-Hex)	Single(Hex)
MTICS70H	MTIC100H	MTIC200H

- Packing unit : Impression coping + Screw
- Used the hex driver
- Transfer type for taking an impression using a ready-made tray
- Impression coping + Screw Order code : A+Product code(ex : AMTIC100H)

Pick-up Impression Coping

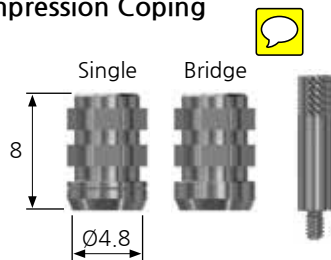

Screw	Bridge(Non-Hex)	Single(Hex)
MPIGP120H	MPIC100H	MPIC200H

- Packing unit : Impression coping + Guide pin
- Used the hex driver
- Pick-up type for taking an impression using a customized tray
- Impression coping + Screw Order code : A+Product code(ex : AMPIC100H)

LAB Analog



Diameter	Code
Ø4.8	MLA480

- Packing unit : Lab analog 
- Multi-unit abutment on a working model

SEWON MEDIX

IMPLANT OVERDENTURE SYSTEM



Prosthetic Flow Diagram 3 

Overdenture

LT/BT Abutment

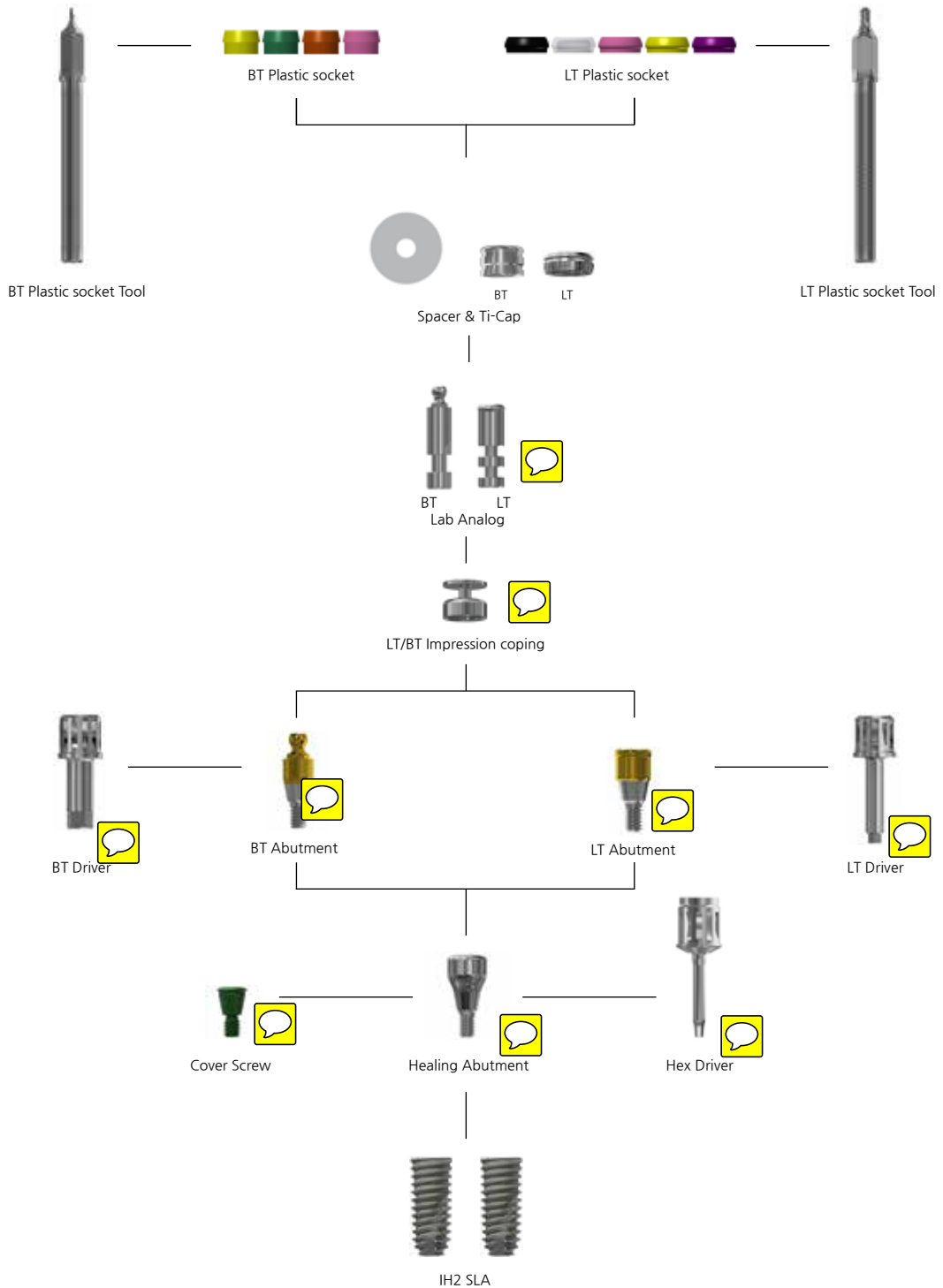

LT Abutment



- Accommodates up to 40° divergence between two implants
- Excellent durability
- Low vertical dimension, stability, and various attachments with retention



Mini



G/H	Code
1.0	IHLAM3510
2.0	IHLAM3520
3.0	IHLAM3530
4.0	IHLAM3540
5.0	IHLAM3550
6.0	IHLAM3560
7.0	IHLAM3570

Regular



G/H	Code
1.0	IHLAR4010
2.0	IHLAR4020
3.0	IHLAR4030
4.0	IHLAR4040
5.0	IHLAR4050
6.0	IHLAR4060
7.0	IHLAR4070

- Tightening torque : 30Ncm
- Use by LT driver
- Abutment + Laboratory set order code : A+Product code+P(ex : AIHLAR4030P)



LT Abutment Components

LT laboratory set



Code	LPSLSP
------	--------

- Component
 - Block-out spacer / Ti-cap connected black laboratory plastic socket
 - Replacement Plastic socket : Yellow/Pink/Clear/Purple
- Used after selecting retention plastic sockets that are appropriate for the case
- Use Plastic socket tool to replace plastic socket
- Packing unit : 1 sets

LT Replacement Plastic Socket

LPSPL

- Laboratory plastic socket
- Colors : Black 
- Quantity : 4 units



LPS07P

- Retention force : 700gr(6.86N) 
- 0 ~ 10°, Yellow
- Quantity : 4 units



LPS09P

- Retention force : 900gr(8.83N) 
- 0 ~ 10°, Pink
- Quantity : 4 units



LPS15P

- Retention force : 1500gr(14.71N) 
- 0 ~ 10°, Clear
- Quantity : 4 units



LPS18P

- Retention force : 1800gr(17.65N) 
- 0 ~ 10°, Purple
- Quantity : 4 units



LT Extended Replacement Plastic Socket



LPS06NP



- Retention force : 600gr(5.88N)
- 0 ~ 20°, Yellow
- Quantity : 4 units



LPS08NP

- Retention force : 800gr(7.84N)
- 0 ~ 20°, Pink
- Quantity : 4 units



LPS10NP

- Retention force : 1000gr(9.8N)
- 0 ~ 20°, Clear
- Quantity : 4 units



LPS15NP

- Retention force : 1500gr(14.71N)
- 0 ~ 20°, Purple
- Quantity : 4 units



Block Out Spacers - LTBOS



- Seals gap between denture cap and abutment
- Quantity : 10 units



LT Impression coping - LTIC55



- Quantity : 4 units



Lab Analog - LTLA120



- LT Abutment Lab Analog
- Quantity : 4 units



LT Abutment Components

LT Torque Driver



Type	Short	Long
Round	LDRS	LDRL
Square	LDSS	LDSL

· Use to tighten LT Abutment 

LT Plastic Socket Tool



LTPST 

· Used in attaching and replacement plastic socket

BT Abutment



- Ball type overdenture prostheses
- Depending on the retention force, the plastic socket comes in different colors
- Used when fixed type implant prosthesis is difficult due to severe bone or soft tissue loss
- Post part is colored in gold



Mini



G/H	Code
1.0	IHBAM2210
2.0	IHBAM2220
3.0	IHBAM2230
4.0	IHBAM2240
5.0	IHBAM2250
6.0	IHBAM2260

Regular

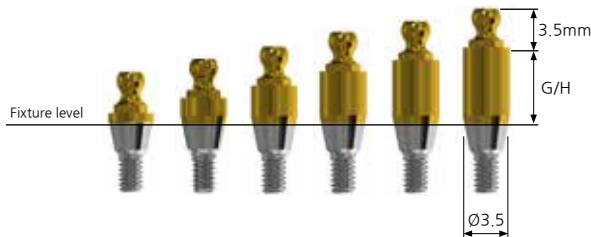

G/H	Code
1.0	IHBAR2210
2.0	IHBAR2220
3.0	IHBAR2230
4.0	IHBAR2240
5.0	IHBAR2250
6.0	IHBAR2260

- Tightening torque : 30Ncm
- Use by BT driver



BT Abutment Components



BT Replacement Plastic Socket



BT Ti-Cap - BATC22



- The size of the titanium cap has been reduced to provide stability and it is designed to strengthen the coherence with resin.
- Quantity : 4 units



BPS22035

- Retention force : 350gr(3.43N)
- 0 ~ 10°, ORANGE
- Quantity : 4 units



BPS22050

- Retention force : 500gr(4.9N)
- 0 ~ 10°, Yellow
- Quantity : 4 units



BPS22090

- Retention force : 900gr(8.83N)
- 0 ~ 10°, Pink
- Quantity : 4 units



BPS22130

- Retention force : 1300gr(12.75N)
- 0 ~ 10°, AQUA
- Quantity : 4 units



BT Impression coping - BTIC22



- Quantity : 4 units



Lab Analog - BTLA22



- BT Abutment Lab Analog
- Quantity : 4 units



BT Abutment Components



BT Torque Driver



Square type

Round type



Type	Short	Long
Round	BDRS	BDRL
Square	BDSS	BDSL

· Use to tighten BT Abutment



BT Plastic Socket Tool



BTPST

· Used in attaching and replacement plastic socket

IH SYSTEM

Ti-Custom Block(HEX TYPE)

- Used to make customized prosthesis
- Packing unit : Ti-Block + Screw
- Tightening torque : Use according to each model

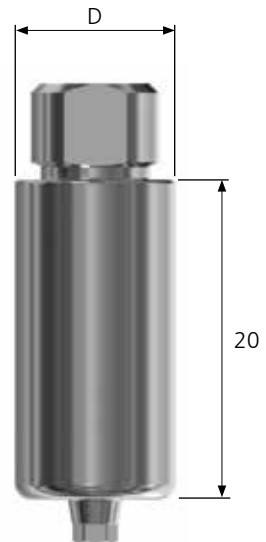

IHCBRH10

Code		Compatible Model	Screw code
Ø10	Ø14		
IHCBMH10	IHCBMH14	TS Mini, Luna Mini	IHASM
IHCBRH10	IHCBRH14	TS Regular, Luna Regular, UF Regular	IHASR
IHCBRH10D	IHCBRH14D	SuperLine, AnyOne, IS Regular	IHASD128

Ti-Custom Block(NON-HEX TYPE)

- Used to make customized prosthesis 
- Packing unit : Ti-Block + Screw
- Tightening torque : Use according to each model

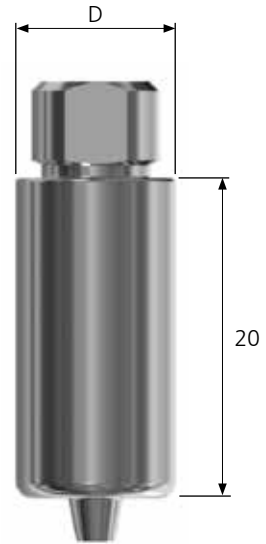

IHCBRN10

Code		Compatible Model	Screw code
Ø10	Ø14		
IHCBMN10	IHCBMN14	TS Mini, Luna Mini	IHASM
IHCBRN10	IHCBRN14	TS Regular, Luna Regular, UF Regular, SuperLine, AnyOne, IS Regular	IHASR

Ti-Custom Block

Code		Compatible Model	Screw code
Ø10	Ø14		
3C34TB10	3C34TB14	BIOMET 3I, Certain, 34mm	IUNIHT
3C41TB10	3C41TB14	BIOMET 3I, Certain, 4.1mm	
3C50TB10	3C50TB14	BIOMET 3I, Certain, 5.0mm	
AATB10	AATB14	Anthogyr, Axiom	ARTS200
ARNTB10	ARNTB14	Ankylos	ATS200
BS37TB10	BS37TB14	BEGO, Semados, Ø3.25/3.75	BPSS200
BS41TB10	BS41TB14	BEGO, Semados, Ø4.1	
BS45TB10	BS45TB14	BEGO, Semados, Ø4.5	
BS55TB10	BS55TB1	BEGO, Semados, Ø5.5	
IB41RTB10	IB41RTB14	Straumann, Bone Level, RC, 4.1mm	IBNBS600
IBNTB10	IBNTB14	Straumann, Bone Level, NC, 3.3mm	IBRBS600
ITB4810	ITB4814	Straumann, Tissue Level, Ø4.8	ITBS600
ITB6510	ITB6514	Straumann, Tissue Level, Ø6.5	
AYXTB10	AYXTB14	ASTRA, Yellow	AYXTS200
AASTB10	AASTB14	ASTRA, Aqua	AASTS200
ALLTB10	ALLTB14	ASTRA, Lilac	ALLTS200
FFNTB10	FFNTB14	FMD, i-Fix, Narrow	FFNTS200
FFRTB10	FFRTB14	FMD, i-Fix, Regular	FFRTS200

• A list of products not available in the EU.

Ti-Custom Block

Code		Compatible Model	Screw code
Ø10	Ø14		
XF30TB10	XF30TB14	XiVE, Friadent Ø3.0	XF30TS
XF34TB10	XF34TB14	XiVE, Friadent Ø3.4	XF34TS
XF38TB10	XF38TB14	XiVE, Friadent Ø3.8	
XF45TB10	XF45TB14	XiVE, Friadent Ø4.5	
XF55TB10	XF55TB14	XiVE, Friadent Ø5.5	
MNTB10	MNTB14	MIS, Internal NP	MNTS200
MSTB10	MSTB14	MIS, Internal SP	MSTS200
NRNTB10	NRNTB14	Nobelbiocare, Replace NP	NRTSN300
NRRTB10	NRRTB14	Nobelbiocare, Replace RP	NRTSR300
NRWTB10	NRWTB14	Nobelbiocare, Replace WP	
NR6TB10	NR6TB14	Nobelbiocare, Replace 6.0	
NANTB10	NANTB14	Nobelbiocare, Active NP	NATSN300
NARTB10	NARTB14	Nobelbiocare, Active RP	NATSR300
DSMNTB10	DSMNTB14	DIO, SM, Narrow	DSTSN600
DSMRTB10	DSMRTB14	DIO, SM, Regular	DSTSR600
MEMTB10	MEMTB14	MEGAGEN, EZPlus, Mini	MEMS200
MERTB10	MERTB14	MEGAGEN, EZPlus, Regular	MERS200
MEWTB10	MEWTB14	MEGAGEN, EZPlus, Wide	MEWS200

• A list of products not available in the EU.

Ti-Base Abutment

- Used for production Ti-Zr custom abutment with CAD/CAM system
- Using SEWONMEDIX official implant library
- Use for production Cement / Screw retained prosthetic abutment
- Fixture level impression



Mini

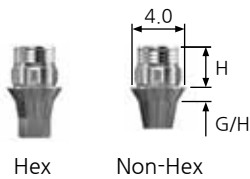

	G/H		1.0	2.0
	H			
Hex	3.0		IHTBM431H	IHTBM432H
	5.0		IHTBM451H	IHTBM452H
Non-Hex	3.0		IHTBM431N	IHTBM432N
	5.0		IHTBM451N	IHTBM452N

• Ti-Screw code : IHASM, Scan Body : IHTBMSB

Regular / D-type

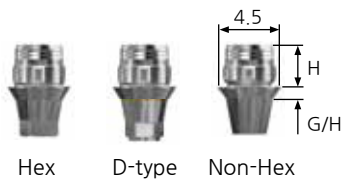

	G/H		1.0	2.0
	H			
Hex	3.0		IHTBR431H	IHTBR432H
	5.0		IHTBR451H	IHTBR452H
D-type	3.0		IHTBR431D	IHTBR432D
	5.0		IHTBR451D	IHTBR452D
Non-Hex	3.0		IHTBR431N	IHTBR432N
	5.0		IHTBR451N	IHTBR452N

• Ti-Screw code : IHASR, Scan Body : IHTBR5B

- Packing unit : Abutment + Screw + Scan Body_Order code : A+Product code(ex : AIHTBR431H)
- Tightening torque : Mini-20Ncm, Regular-30Ncm

SEWON MEDIX IMPLANT SYSTEM

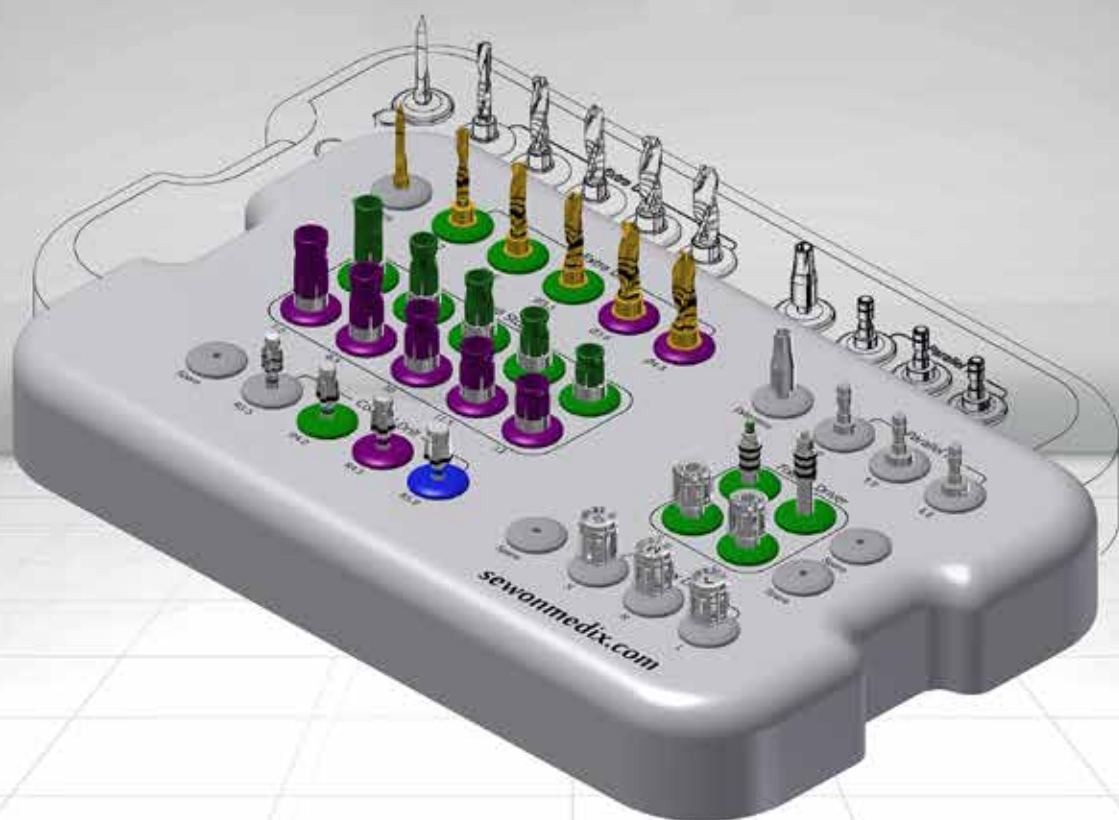

Surgical Kit(K5:Built-in Extra drill)

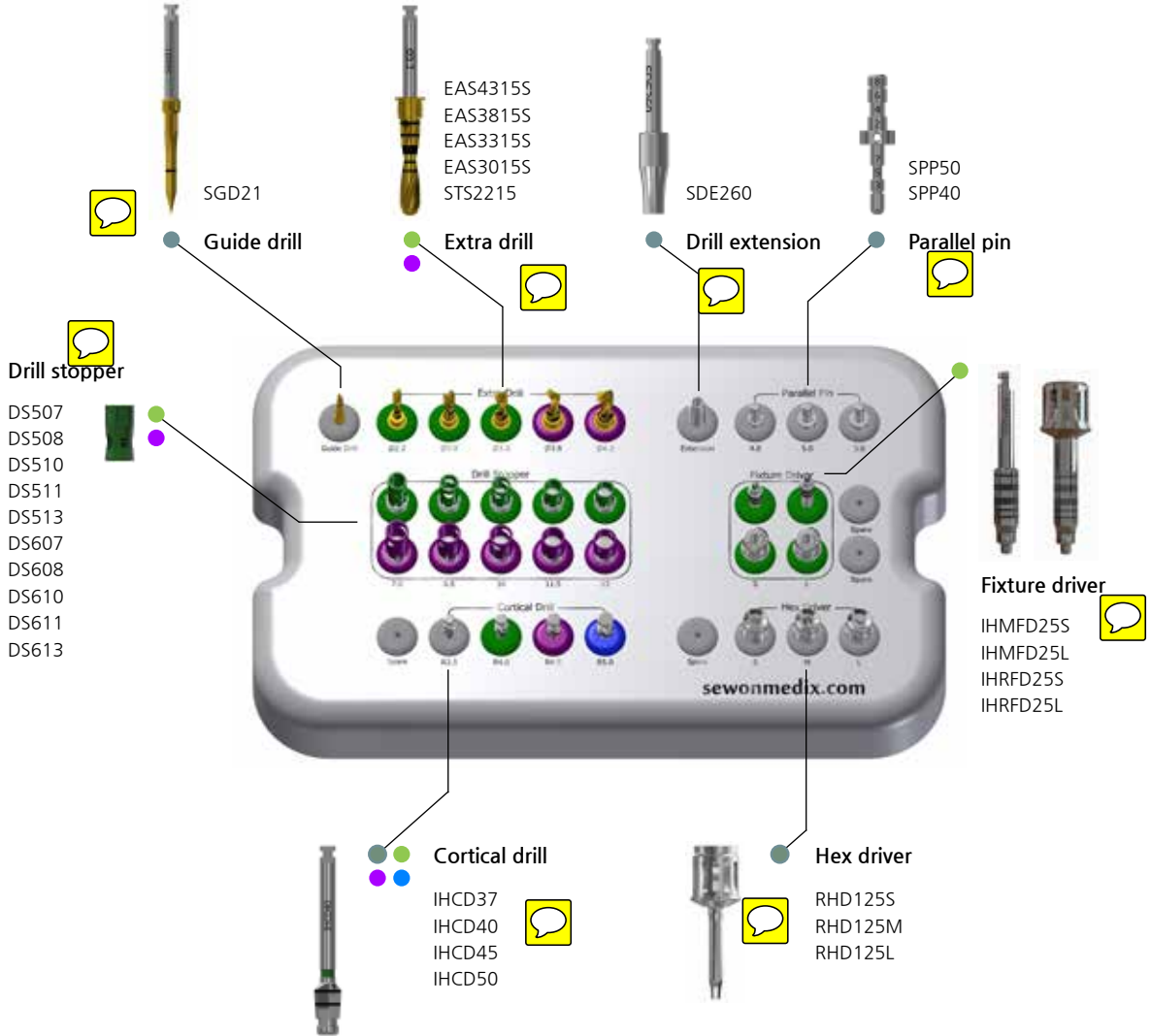

Base components

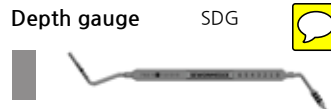

Stopper drill Kit

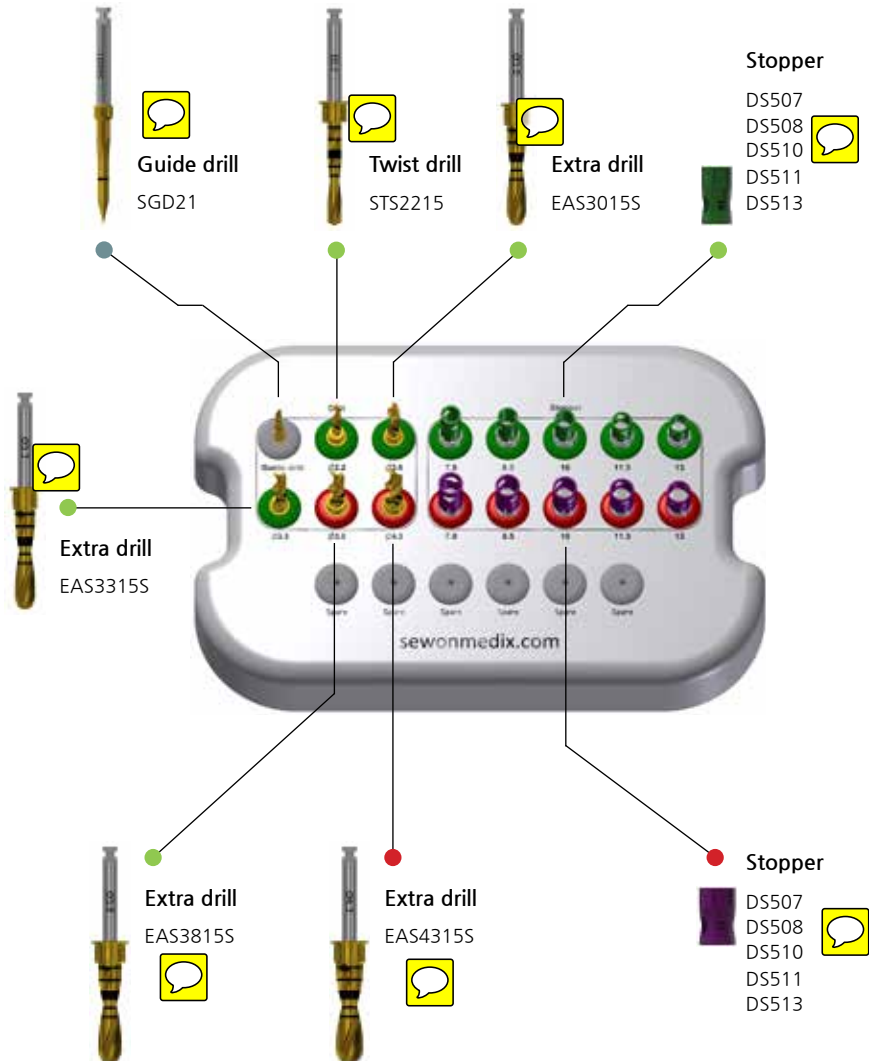

STOPPER DRILL KIT

SEWON MEDIX IMPLANT SYSTEM



Surgical Instruments

Guide Drill



- Forms holes in the bone to facilitate initial drilling 
- Bone density can be determined through drilling
- Tin coating improves anti corrosion and wear resistance

· Order code : SGD21 

Sidecut drill

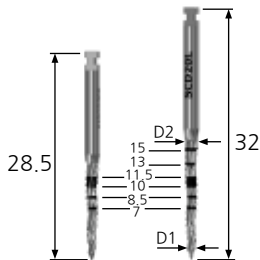

- Correct the angle or position of the osteotomy cutting edge

D1/D2	Ø1.5 / Ø2.0		Ø2.0 / Ø2.5	
Type	Short	Long	Short	Long
Code	IHSCD20S	IHSCD20L	IHSCD25S	IHSCD25L

Drill extension



- Extends the length of a drill and other tools
- Connect the flat side of the drill handle to the flat side of the drill extension

· Order code : SDE260 

Parallel pin

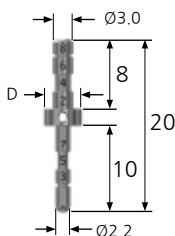



- Confirms drilling direction and location during drilling
- Predicts the diameter of an abutment to be secured

D	Code
Ø4.0	SPP40
Ø5.0	SPP50

Surgical Instruments

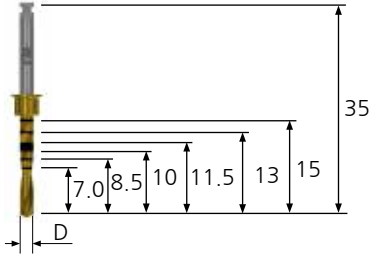
Twist drill (Initial drill)



- Stopper type straight twist drill 
- Tin coating improves anti corrosion and wear resistance

D	Ø2.2	Ø2.7
Code	STS2215	STS2715

Extra drill

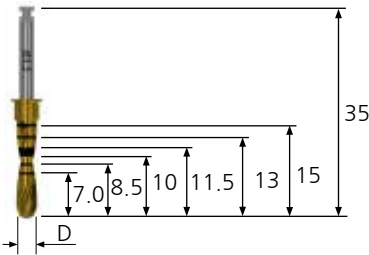

- Stopper type Extra drill 
- Tin coating improves anti corrosion and wear resistance

D	Ø3.0	Ø3.3	Ø3.8	Ø4.3
Code	EAS3015	EAS3315	EAS3815	EAS4315

Final drill

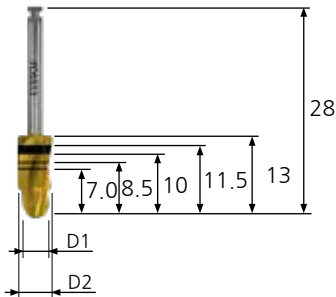

- Final drill: Dual-gear drill that has both pilot drill and twist drill capabilities
- Final drilling can be done right away without pilot drilling
- For Only Ø6.0 Fixture

D1/D2	Ø4.3/5.0	Ø4.3/5.5
Code	FD5013	FD5513

Surgical Instruments

Drill stopper

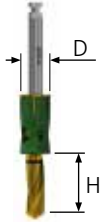

$\begin{matrix} H \\ \backslash \\ D \end{matrix}$	7.0	8.5	10	11.5	13	15
Ø5.0	DS507	DS508	DS510	DS511	DS513	DS515
Ø6.0	DS607	DS608	DS610	DS611	DS613	DS615

· Color : Ø5.0-Green, Ø6.0- Purple

Pilot drill



- Used for the path adjustment of a drilling hole
- When using the next size drill, the guide hole enables precise cutting
- Tin coating improves anti corrosion and wear resistance

Code	SPD30	SPD33	SPD38	SPD43
D1	Ø2.2	Ø2.2	Ø3.0	Ø3.0
D2	Ø3.0	Ø3.3	Ø3.8	Ø4.3

Cortical drill



- Use after forming straight drill hole in normal & hard bone
- The color of drill handle part means the diameter and kind of main mixture to be used
- Yellow : M3.5, Gray : R3.5, Green : R4.0, Purple : R4.5, Blue : R5.0, Red : R6.0

Fixture	M3.5	R3.5	R4.0	R4.5	R5.0	R6.0
Code	IHCD35	IHCD37	IHCD40	IHCD45	IHCD50	IHCD60

Surgical Instruments

Fixture driver

Mini(Ø3.5)

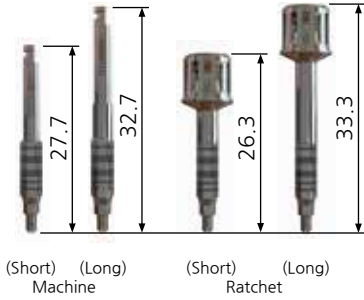

	Machine		Ratchet	
Type	Short	Long	Short	Long
Code	IHMFD21S	IHMFD21L	IHRFD21S	IHRFD21L

Regular(Ø3.5)

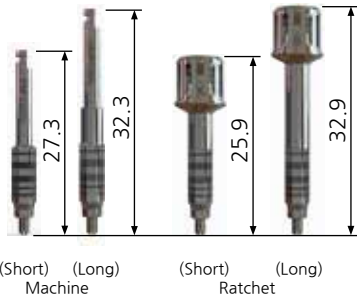

	Machine		Ratchet	
Type	Short	Long	Short	Long
Code	IHMFD25RS	IHMFD25RL	IHRFD25RS	IHRFD25RL

Regular(Ø4.0~6.0)

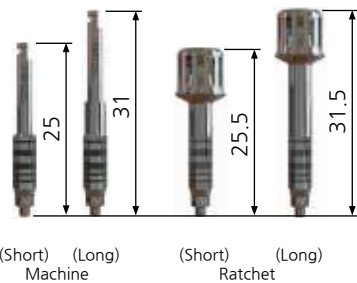

	Machine		Ratchet	
Type	Short	Long	Short	Long
Code	IHMFD25S	IHMFD25L	IHRFD25S	IHRFD25L

- Enable to place fixture without mount
- To enable the simultaneous measurement of gingival height upon treatment, laser marking are indicated at 1mm

· Limited insertion torque : 40Ncm

Surgical Instruments

Mount driver for Machine

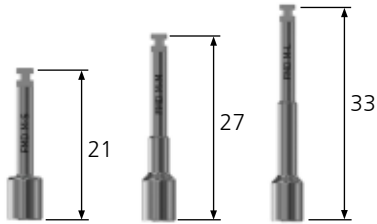

Fixture	Short	Middle	Long
Code	FMDMS	FMDMM	FMDML

Mount driver for Ratchet

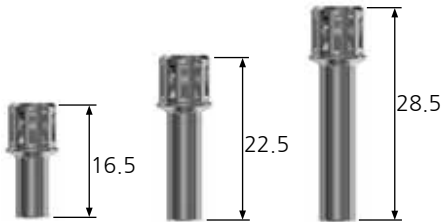

Fixture	Short	Middle	Long
Code	FMDRS	FMDRM	FMDRL

Open Wrench



- Order code : OW700

Depth gauge



- Use as drilling depth measurement and measurement of gingival height.
- Order code : SDG

Surgical Instruments

Torque wrench

Bar type



- Range : 10~30 Ncm
- Used to adjust the implant location or tighten abutment, screw, etc.
- Apply torque after pulling bar to the line indicating torque value to be applied.
- Bar type order code : STW30B / STW50B / STW80B

Spring type



- Range : 10~30 Ncm
- Used to adjust the implant location or tighten abutment, screw, etc.
- Can recognize the bending of the neck part of torque wrench when set torque is applied.
- If force is continuously applied when the neck of torque wrench is bent, excessive torque is applied and there can be a screw fracture issue.
- Spring type order code : STW30S

Ratchet wrench



- Only surgical unlimited wrench.
 (If excessive torque is applied, the inside of bone or fixture may be damaged.)
- Rotating direction is marked by an arrow for convenient identification.
- Order code : SRW

Surgical Instruments

Tissue punch

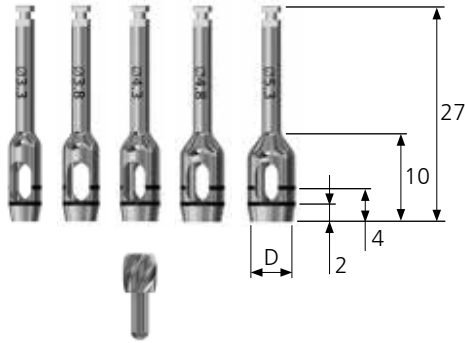

- Tool used for flapless surgery procedure
- Laser marking at 2mm interval, easily measures gingiva height
- Packing unit : Tissue punch + Guide pin
- Recommend using use tissue punch with a 0.7~1.5mm smaller diameter than the healing abutment

D	Ø3.3	Ø3.8	Ø4.3	Ø4.8	Ø5.3
Code	STP33	STP38	STP43	STP48	STP53

Surgical Tap

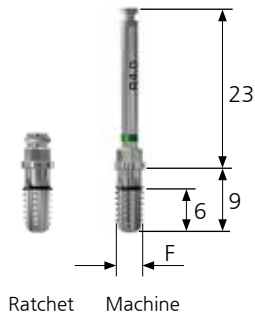

- For Only SEWONMEDIX IH2 Fixture
- Used in hard bone, it forms the thread shape of the fixture
- Use the torque wrench after installing a mount driver for ratchet
- When using the engine, Recommended speed : 25rpm
- Recommend tapping to the marking line lower
- F=Fixture

Type \ F	M3.5	R3.5	R4.0	R4.5	R5.0	R6.0
Machine	IHFTM35	IHFTM37	IHFTM40	IHFTM45	IHFTM50	IHFTM60
Ratchet	IHFTR35	IHFTR37	IHFTR40	IHFTR45	IHFTR50	IHFTR60

Drilling sequence - Extra drill

Mini/Regular Ø3.5mm Fixture (Length : 10.0mm)

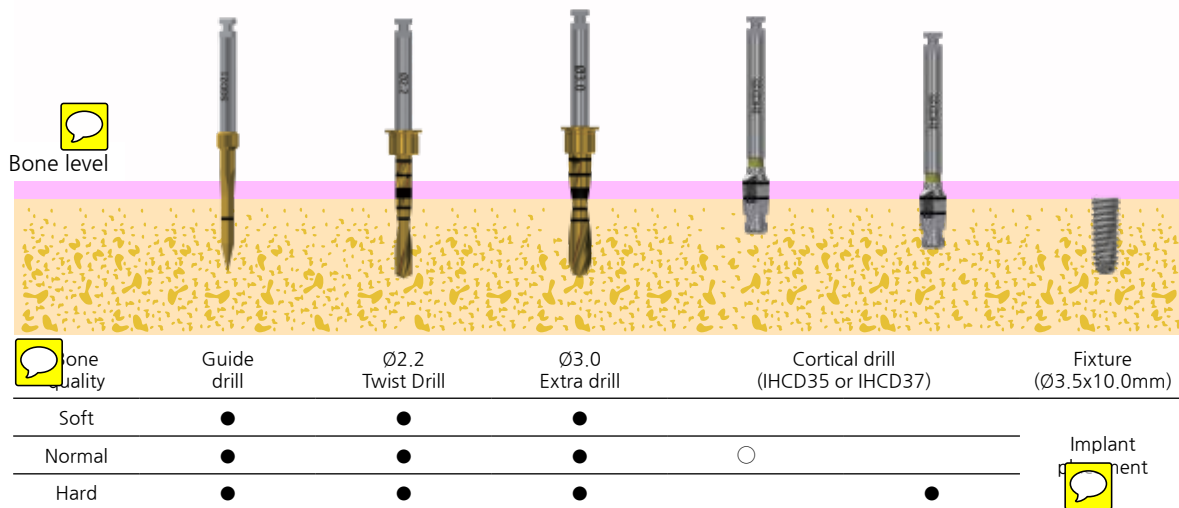

Ø4.0mm Fixture (Length : 10.0mm)

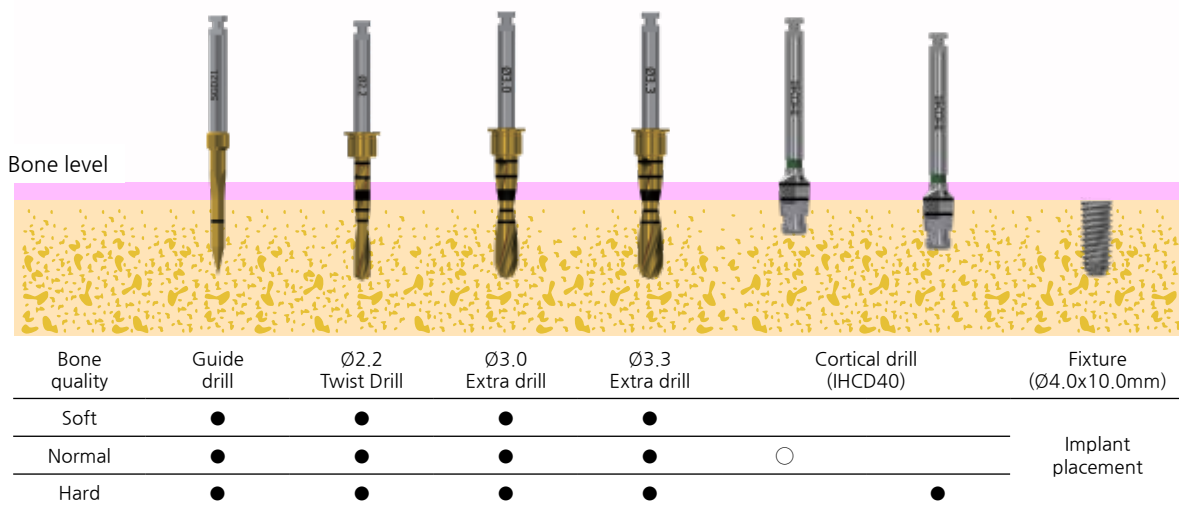

※ ○ : if necessary, use Cortical Drill



Drilling sequence - Extra drill

Ø4.5mm Fixture (Length : 10.0mm)

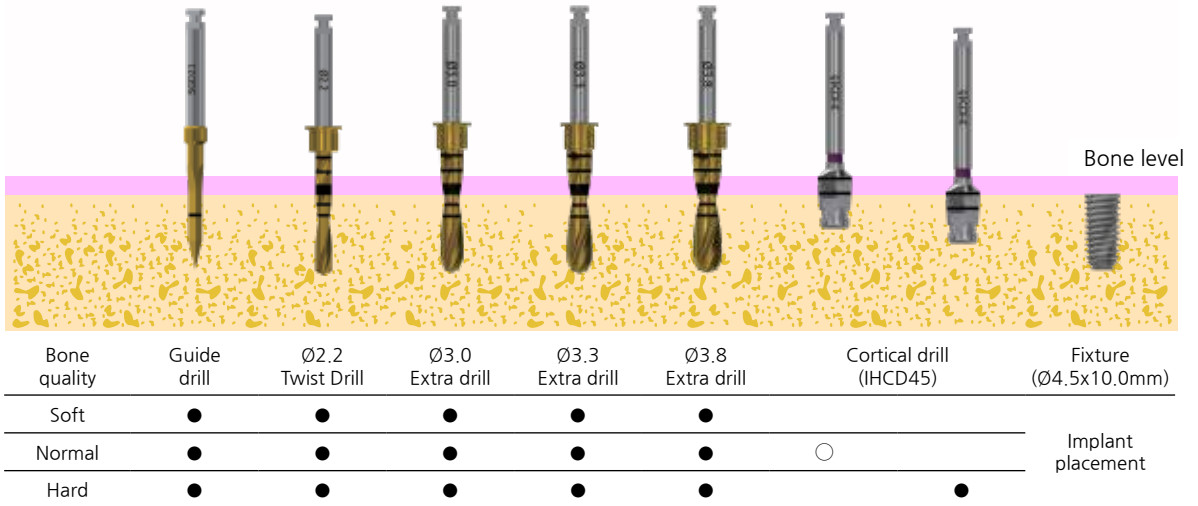

Ø5.0mm Fixture (Length : 10.0mm)

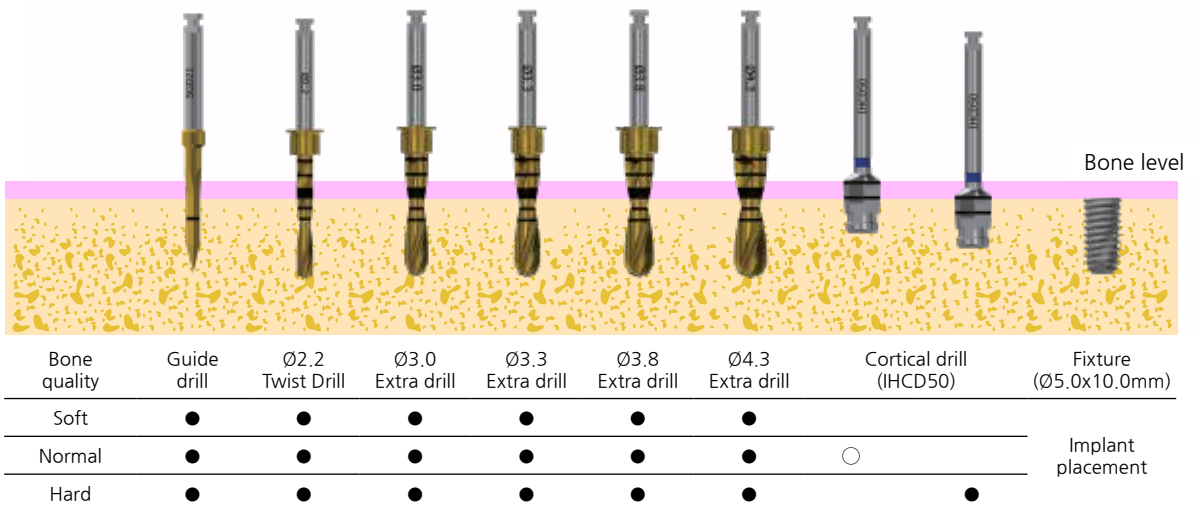

※ ○ : if necessary, use Cortical Drill

Drilling sequence - Extra drill

Ø6.0mm Fixture (Length : 10.0mm)

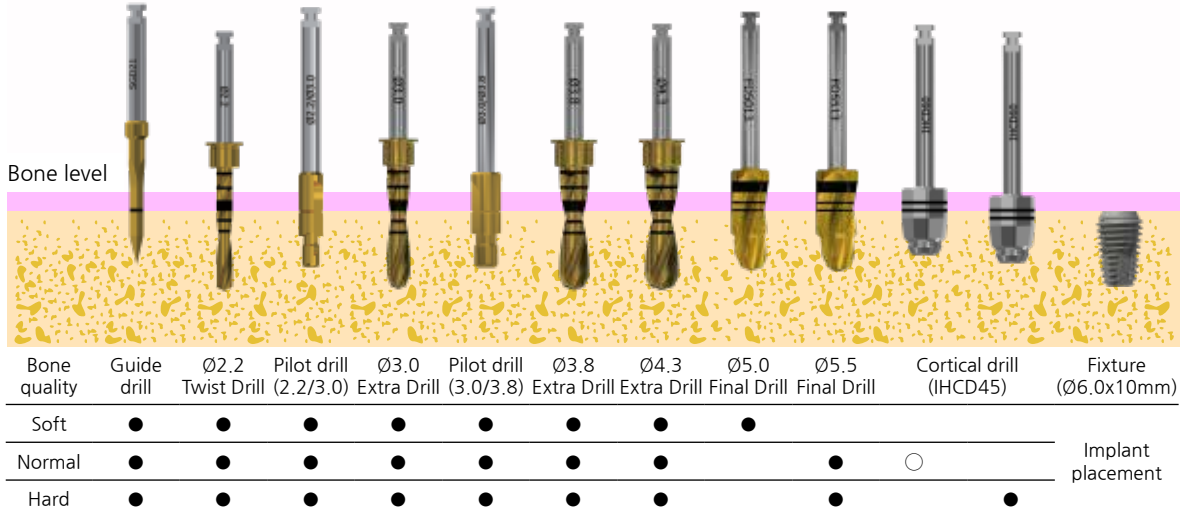

※ ○ : if necessary, use Cortical Drill

SewonGuide Kit(SGK5B)

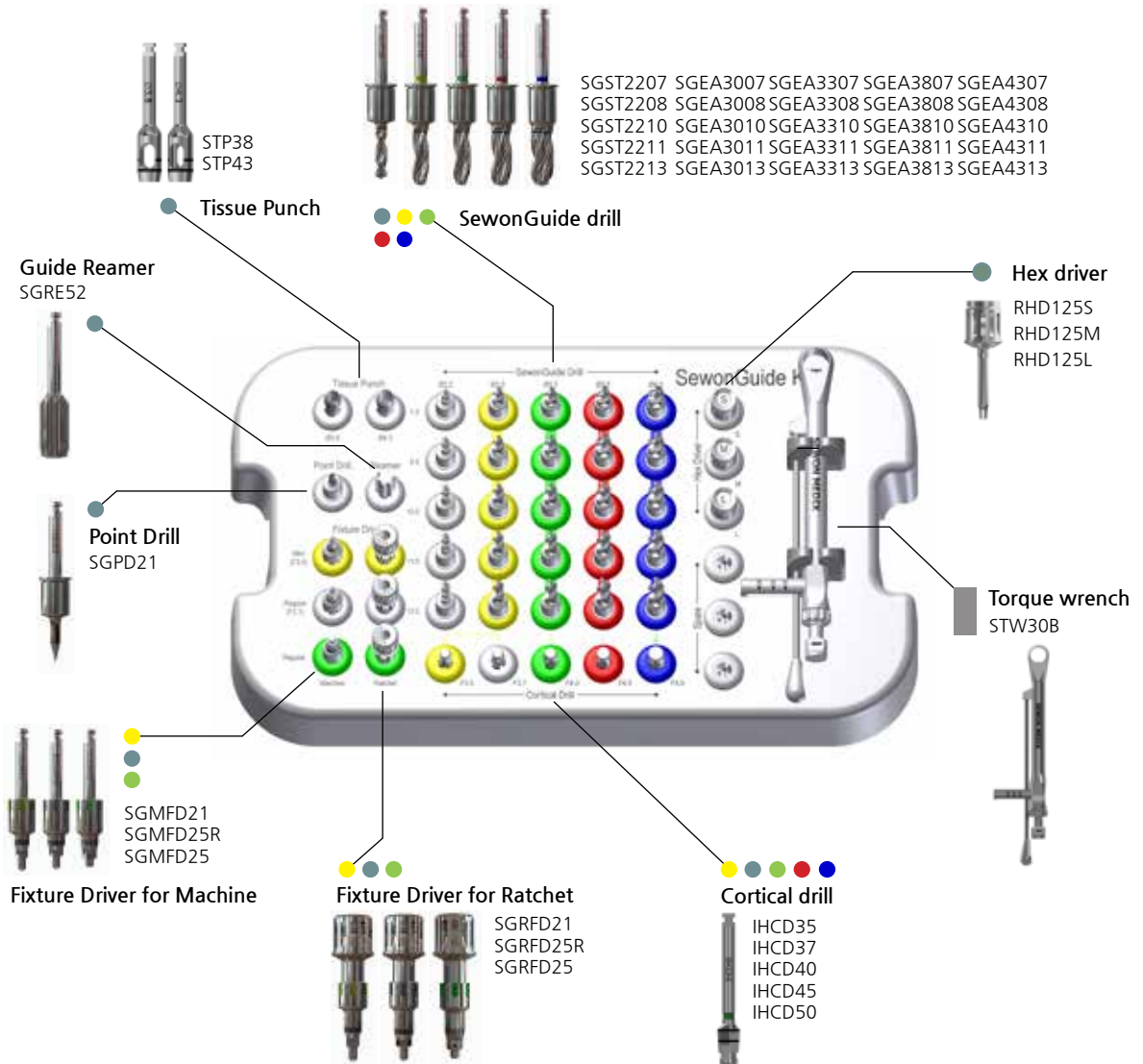

Base components

Open Wrench OW700



Depth gauge SDG



SewonGuide Kit Components

SewonGuide Point Drill



- Forms holes in the bone to facilitate initial drilling
- Bone density can be determined through drilling
- Order Code : SGPD21

SewonGuide Twist Drill

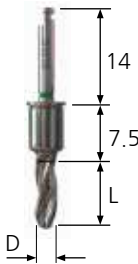

- Extra Drill for digital guide
- Stable drilling without shaking
- Fixture implantation down to 1mm below the bone level
- Use of the cortical drill in the hard bone surgery
- Configure drill by fixture length
(F3.5~F5.0, 7~13mm Fixture Implantation)

L	D				
	Ø2.2	Ø3.0	Ø3.3	Ø3.8	Ø4.3
7	SGST2207	SGEA3007	SGEA3307	SGEA3807	SGEA4307
8.5	SGST2208	SGEA3008	SGEA3308	SGEA3808	SGEA4308
10	SGST2210	SGEA3010	SGEA3310	SGEA3810	SGEA4310
11.5	SGST2211	SGEA3011	SGEA3311	SGEA3811	SGEA4311
13	SGST2213	SGEA3013	SGEA3313	SGEA3813	SGEA4313

SewonGuide Kit Components

Guide Reamer



- Re-work the manufactured guide hole to fit the diameter of the sewonguide
- Order Code : SGRE52

SewonGuide Fixture Driver

Machine type



Fixture	M3.5	R3.5	R4.0~5.0
Code	SGMFD21	SGMFD25R	SGMFD25

- Use for No mount Fixture implantation
- Demand implantation to 80% of the planned fixture implantation depth

Ratchet type



Fixture	M3.5	R3.5	R4.0~5.0
Code	SGRFD21	SGRFD25R	SGRFD25

- After use of machine fixture driver, fixture final a implantation
- Used by tightening wrench to adjust final implantation
- Create the groove in order to match up the Abutment Hex direction
- Final confirm by matching the guide & driver groove

Drilling sequence - SewonGuide drill

(Length : 10.0mm)

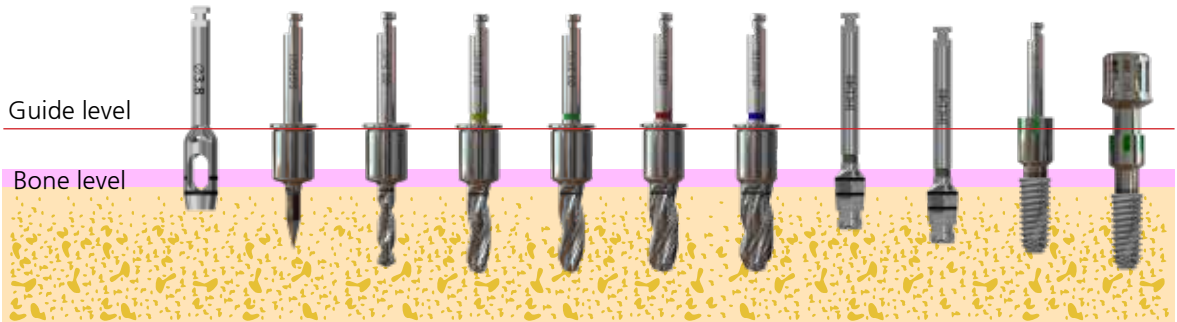

Fixture diameter	Bone quality	Tissue Punch	Point Drill	Guide Drill(Ø2.2)	Guide Drill(Ø3.0)	Guide Drill(Ø3.3)	Guide Drill(Ø3.8)	Guide Drill(Ø4.3)	Cortical Drill	Fixture Driver for Machine	Fixture Driver for Ratchet
F3.5 (Mini, Regular)	Soft	●	●	●	●					●	●
	Normal	●	●	●	●				○	●	●
	Hard	●	●	●	●				●	●	●
F4.0	Soft	●	●	●	●	●				●	●
	Normal	●	●	●	●	●			○	●	●
	Hard	●	●	●	●	●			●	●	●
F4.5	Soft	●	●	●	●	●	●			●	●
	Normal	●	●	●	●	●	●		○	●	●
	Hard	●	●	●	●	●	●		●	●	●
F5.0	Soft	●	●	●	●	●	●	●		●	●
	Normal	●	●	●	●	●	●	●	○	●	●
	Hard	●	●	●	●	●	●	●	●	●	●

※ ○ : if necessary, use Cortical Drill

Expander Kit (SEPK3B)

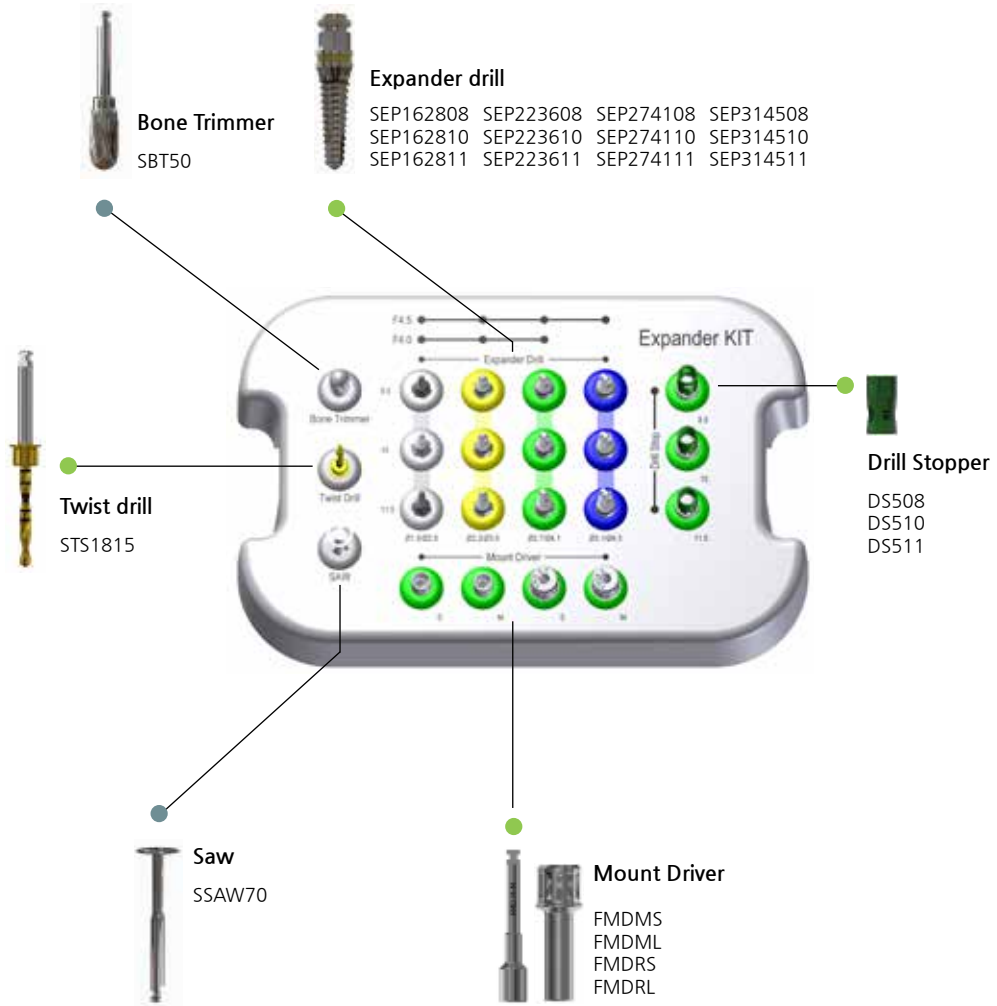

Base components

Open Wrench OW700



Torque Wrench STW30B



Expander Kit Instruments

Bone Trimmer

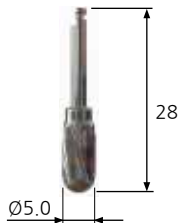

- Horizontal modification of the crest bone
- Recommended speed : 1,200~1,500rpm
- Order Code : SBT50

Twist Drill

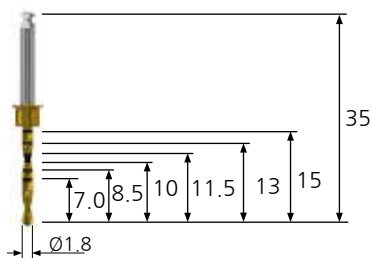

- Implantation position Marking
- Control the depth of fixture implantation by drill stop
- Recommended speed : 1,200 ~ 1,500rpm
- Order Code : STS1815

Saw



- For ridge modification and splitting
- Cut vertically and incise the whole part from mesial → distal direction
- Recommended speed : 1,200~1,500rpm
- Order Code : SSAW70

Expander Drill

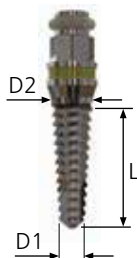

- Incisional bone width expand
- Gradually expands bone width
- Recommended speed : 25~35rpm

L \ D1/D2	Ø1.6/2.8	Ø2.2/3.6	Ø2.7/4.1	Ø3.1/4.5
	8.5	SEP162808	SEP223608	SEP274108
10	SEP162810	SEP223610	SEP274110	SEP314510
11.5	SEP162811	SEP223611	SEP274111	SEP314511

Prosthetics Kit(PK5B)

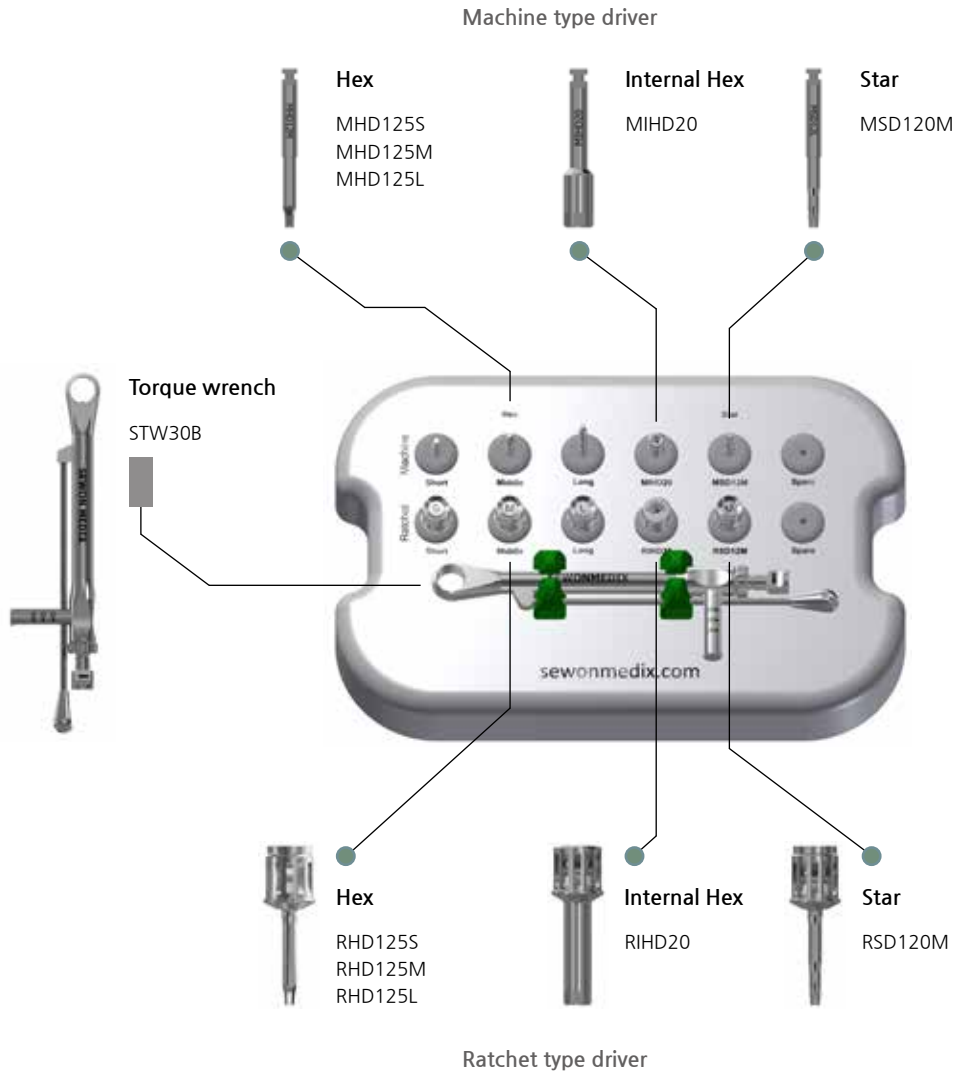

Prosthetic Kit(PK125B)

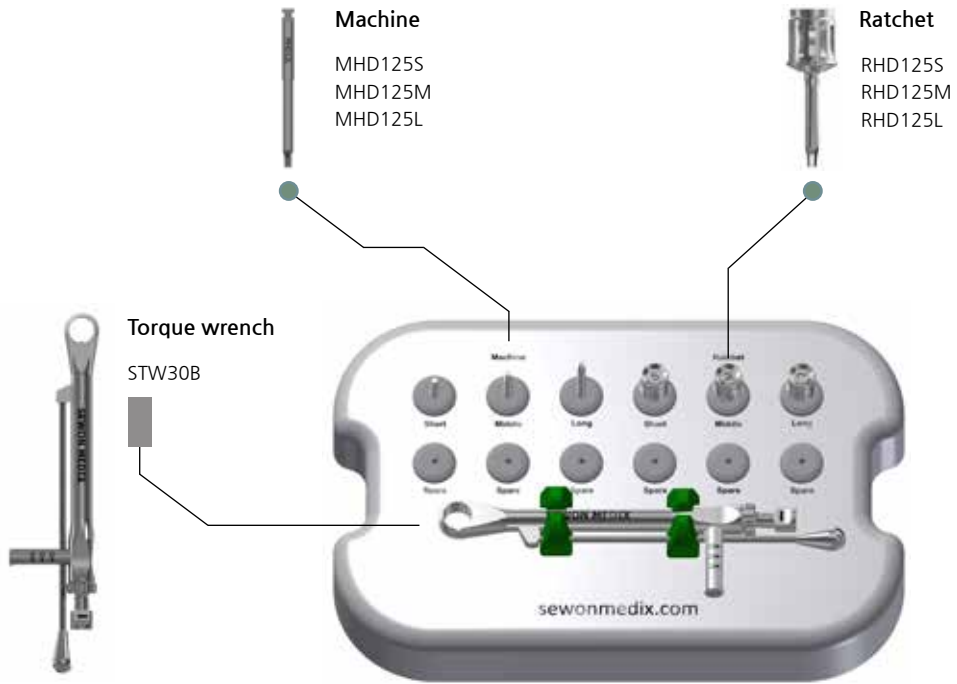

Prosthetic Instruments

Screw driver for Machine

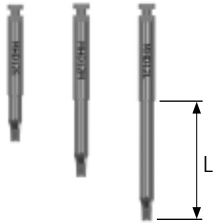

Type \ L	6.0mm	12.0mm	18.0mm
Hex 1.20	MHD120S	MHD120M	MHD120L
Hex 1.23	MHD123S	MHD123M	MHD123L
Hex 1.25	MHD125S	MHD125M	MHD125L
Hex 1.28	MHD128S	MHD128M	MHD128L
Star 1.20	MSD120S	MSD120M	MSD120L

Screw driver for Machine - Ball type

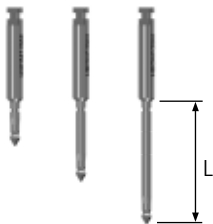

Type \ L	6.0mm	12.0mm	18.0mm
Hex 1.20	HBDM120S	HBDM120M	HBDM120L
Hex 1.23	HBDM123S	HBDM123M	HBDM123L
Hex 1.25	HBDM125S	HBDM125M	HBDM125L
Hex 1.28	HBDM128S	HBDM128M	HBDM128L
Star 1.20	SBDM120S	SBDM120M	SBDM120L

Prosthetic Instruments

Screw driver for Ratchet



Type \ L	6.0mm	12.0mm	18.0mm
Hex 1.20	RHD120S	RHD120M	RHD120L
Hex 1.23	RHD123S	RHD123M	RHD123L
Hex 1.25	RHD125S	RHD125M	RHD125L
Hex 1.28	RHD128S	RHD128M	RHD128L
Star 1.20	RSD120S	RSD120M	RSD120L

Screw driver for Ratchet - Ball type

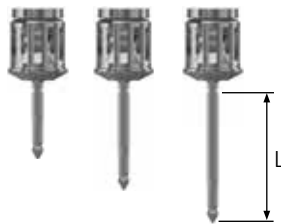

Type \ L	10.0mm	14.0mm	18.0mm
Hex 1.20	HBDR120S	HBDR120M	HBDR120L
Hex 1.23	HBDR123S	HBDR123M	HBDR123L
Hex 1.25	HBDR125S	HBDR125M	HBDR125L
Hex 1.28	HBDR128S	HBDR128M	HBDR128L
Star 1.20	SBDR120S	SBDR120M	SBDR120L

Prosthetic Instruments

Screw driver for Square



Type \ L	6.0mm	12.0mm	18.0mm
Hex 1.20	SHD120S	SHD120M	SHD120L
Hex 1.23	SHD123S	SHD123M	SHD123L
Hex 1.25	SHD125S	SHD125M	SHD125L
Hex 1.28	SHD128S	SHD128M	SHD128L
Star 1.20	SSD120S	SSD120M	SSD120L

Screw driver for Square - Ball type

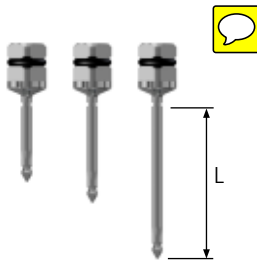

Type \ L	10.2mm	14.2mm	18.2mm
Hex 1.20	HBDS120S	HBDS120M	HBDS120L
Hex 1.23	HBDS123S	HBDS123M	HBDS123L
Hex 1.25	HBDS125S	HBDS125M	HBDS125L
Hex 1.28	HBDS128S	HBDS128M	HBDS128L
Star 1.20	SBDS120S	SBDS120M	SBDS120L



Prosthetic Instruments

Hand driver

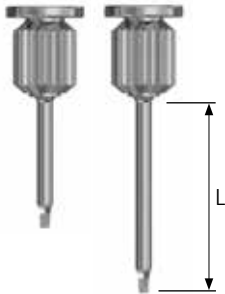

Type \ L	16.6mm	20.6mm	24.6mm
Hex 1.20	SDH120S	SDH120M	SDH120L
Hex 1.23	SDH123S	SDH123M	SDH123L
Hex 1.25	SDH125S	SDH125M	SDH125L
Hex 1.28	SDH128S	SDH128M	SDH28L
Star 1.20	SDHS120S	SDHS120M	SDHS120L

Internal hex driver (for Multi-unit abutment)

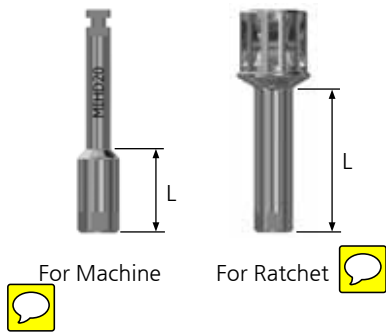

Type \ L	9.0mm	15.0mm
Machine	MIHD20S	MIHD20L
Ratchet	RIHD20S	RIHD20L

Driver connect

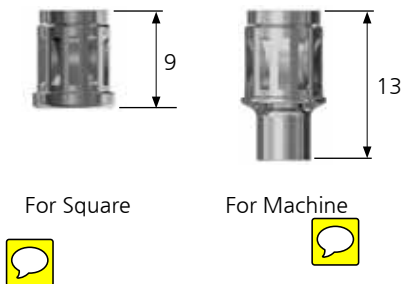

Type	For Square	For Machine
Code	DCS100	DCM120

Appendices



Precautions for use & Warnings	102
Surgical KIT Maintenance	103
Instructions for use	104
Material characteristics	108

Precautions for use & Warnings

Precautions for use

- The hand-piece should be moved vertically up and down during bone drilling. (pumping).
- Saline solution must be applied during bone drilling in order to reduce frictional heat generated from bone drilling.
- Laser marking is a dimension indication line, and the bottom of laser marking is the standard. For laser marking of all drills, the 11.5mm and 13mm levels are marked in bold line.
- The drill and the driver are recommended to be used for 50 times respectively. The maximum allowable torque is 20Ncm for mini size abutment and 30Ncm for regular size abutment.
- If the drill or the driver is used exceeding the recommend number of use, implant failure may occur due to loss of product function caused by abrasion and fracture of the driver, or due to bone heating caused by declined cutting force of drill. Please, follow the recommendations.
- The dental practitioner should properly determine the bone condition of the patient and apply appropriate cutting speed.
- The length of drill stopper means the remained actual length of twist drill when the drill stopper is installed on drill.
- Small instruments should be fixed with a wire before use because they may be moved into the throat during the procedure.
- Please, immediately detach and clean all the instruments used for the procedure. Store them at the room temperature after drying them.
- Do not keep instruments in a place where the risk of infection exists.
- This product is a medical device and must be sterilized in an autoclave before use.
- Do not use hydrogen peroxide, which is generally used as a disinfecting and cleaning agent, since TiN coating, laser marking, and color coding may be damaged or discolored.
- The warranty period of this product is one year from the date of purchase.

Warnings

For safe and effective use of the SEWONMEDIX implant system, we strongly recommend that dental implant procedures be performed by a person who has completed professional training courses because such procedures are highly specialized and complicated. Improper patient selection and technique may result in implant failure or bone loss. The SEWONMEDIX implant system should be used, following only the described instructions for use. Any arbitrary change in using methods is not accepted for dental implants. Do not use an electro-surgical instrument or laser around the fixture or abutment because an electro shock may occur. Implant mobility, bone resorption and chronic infection mean implant failure. If an implant is infected by a patient's body fluid for one cause or another, the implant cannot be used for another patient.

Surgical KIT Maintenance

• Methods of cleaning and sterilization

Instruments must be cleaned and sterilized before re-use. Please, observe the following instructions 

< Cleaning >

- Remove the contaminants (skin tissue, blood, bone chips etc.) remaining on the instrument used for the procedure.
- Submerge the instrument for 10 minutes in alkaline cleaning solution or other similar cleaning solution.
- Then, remove all visible contaminants with a soft brush.
- Use distilled water to completely wash the remaining cleaning solution on the surface of the instrument.
- Place the instrument into the cleaning container in an ultrasonic cleaner and fill it with water.
- Perform ultrasonic cleaning at the room temperature for 10 minutes.
- Wipe the washed instrument with a non-abrasive cloth and then keep it in a dry place.

< Sterilization >

- Sterilize non-sterile instruments in an autoclave before use.
- Sterilize the instruments in an autoclave (for 15 minutes at 132 °C) and then dry for 30 minutes.
- Store the sterilized instruments in a clean environment between 10°C and 30°C.

Instructions for use

SEWON MEDIX IMPLANT SYSTEM_IH SYSTEM

Version 4.0 / Date : July 2018

Information regarding the use of fixtures, abutments, prosthetic components and surgical instruments

Description of the system

SEWONMEDIX products are dental implants and materials are as follows.

Classification	Material
Fixture	Titanium
Abutment	Titanium, CCM(Cr-Co-Mo)
Prosthetic material and surgical instruments	Titanium, Stainless steel, Polymer

See our product catalog/home page (www.sewonmedix.com) for detailed information on each product.

For product code, specification, date of manufacture, and expiry date, see the label attached to the product.

Indication for Use

The SEWONMEDIX IMPLANT SYSTEM is designed for dental implant surgery; it is placed on the maxillary or mandibular alveolar bone through a surgical operation, and after osseointegration with the alveolar bone, it can replace a lost tooth by connecting the abutment post. The SEWONMEDIX IMPLANT SYSTEM is indicated for use in partially or fully edentulous mandibles and maxillae, in support of single or multiple-unit restorations including: cemented retained, screw retained, or overdenture restorations, and final or temporary abutment support for fixed bridgework. The abutment is intended for use with a dental implant fixture to provide support for prosthetic restorations such as crown, bridge, or overdenture.

1. Selection criteria/indications

Analysis of local and systemic contraindications, "Normal" wound healing capacity, effective oral hygiene/healthy remaining teeth, growth of maxilla and mandible complete, good general medical condition, adequate supply of healthy jaw bone.

2. Local examination

Anatomy of the alveolar ridge, intermaxillary relationships, deep bite, quality and thickness of the mucosa, study models and bite registration on the articulator, radiographic findings.

Use of the SEWONMEDIX system

1. Preparations before use

- ① The dentist should be fully aware of the product and the procedure and should explain the limits of implants to the patient prior to use. And the patient should clearly understand the implant's functionality and its aesthetic limits.
- ② Selecting and fixing a proper implant is an important factor affecting the lifespan of the implant, so it is required to strictly follow indications, contraindications, precautions and warnings.
- ③ Thoroughly examine the condition of the patient before procedure and prepare a procedural planning for the patient. Failure to do it may lead to implant loss.
- ④ Read X-ray pictures well and make the right choice of the

product for the patient.

- ⑤ Check the packaged condition of the product and expiry date and also check the product for damage.
- ⑥ The product is supplied "sterile". Do not use the product if the packaging has been previously opened or broken.
- ⑦ Contamination of a surgical instrument may lead to implant loss, so check if surgical instruments are kept in a clean condition.

2. Directions for use

Please use the product according to general implant procedure guides.

<Fixture>

- ① Take an X-ray picture and choose an implant site.
- ② Make an incision in the gum with a scalpel at the chosen site.
- ③ If the bone is exposed, position the implant at the implant site using a guide drill.
- ④ Use an initial drill to drill an initial hole to fit the length of the fixture at the site. The depth of the drilled hole can be measured by a depth gauge.
- ⑤ After the Initial Drill is used, select a middle drill and a final drill based on the diameter of the fixture to conduct drilling.
- ⑥ The dentist should select the final drill to fit the diameter of the fixture to be implanted based on the patient's bone quality, and should conduct drilling with proper rotational speed maintained.
- ⑦ Check if the implant inside the ampoule is properly connected with the Machine Fixture Driver suitable for each product. After ensuring the fit, remove the implant carefully from the ampoule and implant it in a selected position by rotating in a clockwise direction. At this time, please make sure that implantation torque above 50Ncm should not be applied.
- ⑧ After implantation is completed, connect the cover screw to the implant with less than 15Ncm torque and then suture the surgical site to protect the implant.
- ⑨ After the implantation, the patient should avoid drinking alcohol and smoking and should maintain good oral hygiene in order to prevent contamination and infection.
- ⑩ Allow three to six month healing time depending on the patient, and then the dental practitioner should check for osseointegration and decide to conduct the prosthetic procedure.

<Abutment>

- ① Take an impression after soft tissue is healed. (It is possible immediately after the healing abutment removal in the case of One Stage Surgery.)
- ② Make the right type and size of abutment by comparing the radiograph with the taken impression and by considering adjoining teeth.
- ③ Non-sterile products should be sterilized in an autoclave at 132°C for at least 15 minutes, and then allow a drying time of more than 15 minutes.
- ④ Connect the chosen abutment to the fixture in the mouth.
- ⑤ Take an impression at either fixture level or at abutment level in order to manufacture the final prosthesis.
- ⑥ In the case of cement-retained prosthesis, use a hard finishing plaster to do a wax-up on the abutment, and manufacture the prosthesis.
- ⑦ Attach the final prosthesis to the implant or the abutment in the mouth and connect it to the fixture and then check the occlusion

Instructions for use

between the upper and lower jaws.

⑧ Recommended tightening torque in tightening abutment screws is as follows.

Classification	Recommended torque
Cylinder Screw	20N·cm
Abutment Screw (Mini)	20N·cm
Abutment Screw (Regular)	30N·cm
Temporary Abutment	20N·cm

Modification or Customization of Abutment

The Abutment may be modified if required due to the patient's anatomy. And IH Temporary Abutment and IH FreeMilling Abutment are designed especially for patient-specific customization.

IH Temporary Abutment is temporarily used until final prosthesis is made to maintain esthetic appreciation. The minimum post height of the IH Temporary Abutment is 4mm. The post diameter, wall thickness of the IH Temporary Abutment cannot be modified. There is no angular correction for the IH Temporary Abutment.

The minimum post height of the IH Free Milling Abutment is 4mm and the minimum post diameter is 0.4mm. The wall thickness can be modified up to 0.2mm. There is no angular correction for the IH FreeMilling Abutment.

IH Temporary Abutment and IH FreeMilling Abutment are modified by hand-milling.

Multi-unit loaded Restorations

Non-Hex types of all IH Abutments are intended for multi-unit loaded restorations. Solid Abutment, Cement Abutment (Non-Hex type), IH Angled Abutment(Non-Hex type), IH Temporary Abutment(Non-Hex type), Multi-unit Abutment and FreeMilling Abutment(Non-Hex type) are intended for multi-unit restorations. IH Multi-unit Abutment can be used for single-unit loaded restoration when it is combined with Multi-unit Cylinder. The minimum post height of the IH Multi-unit Abutment combined with Multi-unit Cylinder is to be at least 4mm. (No angular correction)

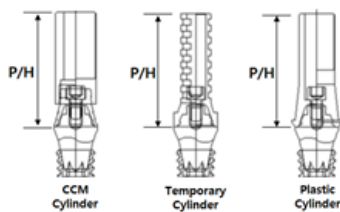

Post Height : 12mm

12mm

12mm

Precautions for use

1. Contraindications

Placement of dental implant may be contraindicated based on patient's medical condition.

The dental implant should not be used for the following patients:

- ① Patients with a history of heart failure or artery hardening;
- ② Uncooperative patients or patients with mental or physical disorder which may result in unstable implant, failure to fix the implant or complications in management after operation;
- ③ Patients with the problem in bone remodeling, microcirculation

or blood clotting function;

④ Pregnant patients; and

⑤ Patients with high blood pressure or diabetes mellitus.

⑥ Patients with bone disease(osteoporosis, osteomalacia) or Bone metabolism disorders.

2. Procedural precautions of surgery

① When the dental practitioner places the final prosthesis in the patient's mouth, he or she must check osseointegration of the implanted fixture by using radiographs, the stability testing machine and percussion test.

② Torque within the specified torque range should be applied in tightening abutment screws. If a screw is tightened beyond the torque range, it may cause damage to the driver and the function part and also cause screw fracture. Also, tightening torque less than the torque range may lead to loosening. Thus, recommended tightening torque described in Directions for Use section must be followed.

③ In connecting the screw to the fixture, special attention should be paid not to apply excessive force until tightening of the first screw thread is confirmed when the screw is exactly in line with tightening direction. If the tightening of the first screw thread is not smooth, it may lead to damage to the fixture and the screw thread of the abutment, causing product damage or tightening failure.

④ Prosthesis should be designed in such a way that masticatory force is not applied excessively leaning to one side. If not, fracture of prosthesis due to stress concentration may be caused.

3. Warnings

① Improper technique in either implant placement or restoration can result in implant failure and substantial loss of surrounding bone. So, implants should be used by trained and experienced dentists.

② Implants must not be used again and they should be applied based on their original purposes.

③ If the implant is damaged or improperly handled, it should be removed.

④ If the implant is improperly chosen or if the implant site is improper and fixed condition is unstable, the lifespan of the implant may be reduced.

⑤ Defected products should be returned.

⑥ Special attention should be paid in handling implants to prevent implant damage or deformation.

4. Procedural Precautions of Restoration

Allow sufficient healing period for osseointegration to occur after implantation. The dental practitioner should closely monitor patients and decide to move to the next step. Excessive pressure including chewing pressure should not be applied to the dental fixture during the healing period.

5. Potential unfavorable consequences

Potential unfavorable consequences associated with the use of dental implants may include:

- ① Dehiscence of bone, delayed healing, swelling;
- ② Hematoma, infection, and inflammation; and
- ③ General hypersensitivity etc.

6. Side Effect

① Implant surgical procedure may accompany with risk such as swelling of certain parts, tear and opening of tissues, temporary

Instructions for use

hightened sensations, edema, embolism, bleeding etc.

② Loss of sensation on lower lip, surgical side effects on jaw during mandibular surgery, and nose and surrounding tissue during maxillary surgery may result from the operations. Most of symptoms are expected to be temporary though permanent paralysis may be resulted.

③ Necrosis of mucosa of gingiva (gum tissue), and infections on cell tissue may occur. However, these are common with localized treatment.

7. Adverse Effect

① Low stability during early stage, failure of osseointegration, and inappropriate prosthodontics may occur even after the surgery.

② Low quantity and quality of reaming bone, poor oral hygienic by patients, lack of cooperation by patients, and metabolic diseases such as diabetes may cause the reason for failure in some patients.

• Handling & Storage

The product is intended only for single use. It must not be re-used.

Keep the product in a dry place at room temperature. Keep away from direct sunlight.

*Cleaning & Sterilization Information

- IH Prosthetic System

The prosthetic components supplied non-sterile should be performed following user sterilization method provided by SewonMedix Inc. Remove the prosthetic components from packaging prior to sterilization. We recommend the product to be sterilized with moist heat sterilization using the gravity displacement autoclave for 15 minutes at temperatures 132 °C (269.6 °F) and to be dried for 15 minutes. FDA-cleared accessories (e.g., pouch, wrap, tray) are to be used during the sterilization of the prosthetic components. The recommended sterilization parameters listed above have been validated to a SAL of 10⁻⁶ in accordance with a FDA-recognized standards such as ISO 17665 using bioburden sterilization method. After using the surgical instruments, select a suitable method of cleaning that removes all visible contamination from the product and distilled water. All non-sterile components of this system MUST be sterilized prior to use.

OVERDENTURE COMPONENTS

Version 1.0 / Date : September 2018

SEWON MEDIX IMPLANT SYSTEM

Information regarding the use accessories of the attachment for dentures.

Device description and indications for use

The LT/BT Plastic Sockets are retentive elastic components for the construction of over-dentures attachments.

The ANALOG, IMPRESSION, BLOCK OUT SPACER line is composed by prefabricated accessories for the correct use of the attachment for dentures.

The Ti-CAP is prefabricated for the construction of removable prostheses.

Contraindications

At the present state of knowledge there are no contraindications to the use of the LT/BT Plastic socket, Ti-CAP, ANALOGS, IMPRESSIONS, BLOCK OUT SPACER; at the date of emission of

these instructions for use no undesirable side effects have been reported.

Caution

The choice of the attachment is demanded to the dentist or to the dental technician according to the prosthetic project.

Material

All the materials used for the LT/BT PLASTIC SOCKET, Ti-CAP, ANALOG, IMPRESSION COPPING, BLOCK OUT SPACER are of quality and meet the international standards of reference. The patient has to inform the dentist about potential allergies. If allergic reactions occur search the source and remove it.

Classification	Material
Plastic socket	Polyamide, POM
Ti-Cap	Titanium
Prosthetic material and surgical instruments	Stainless steel, POM, Titanium

Warnings and single use

The LT/BT PLASTIC SOCKET, Ti-CAP, ANALOG, IMPRESSION COPPING, BLOCK OUT SPACER are single-use products; their reuse undermines the functionality and may affect the patient's health. Improper use or reuse of LT / BT PLASTIC SOCKET, Ti-CAP, ANALOG, IMPRESSION COPPING, PROTECTIVE DISK are prohibited.

Transportation, storage and expiration date

Do not damage the packaging during the transportation; store in a clean, dry place, in the original packaging away from sunlight and heat sources. The product does not expire.

Washing and sterilization

The content of the set are sold as NON STERILE: the dentist is required to pack and store the prefabricated metal parts in cleared FDA 510(k) pouches (paper/plastic film) suitable for sterilizing and have to sterilize them before use with the following parameters: steam sterilization with prevacuum cycles at 135°C-3minutes, drying time 16minutes, pressure 2.06 bar. It is recommended to sanitize LT/BT PLASTIC SOCKET, Ti-CAP, ANALOG, IMPRESSION COPPING, BLOCK OUT SPACER with benzalkonium chloride solutions before use. The dentist is responsible of the sterilization.

Maintenance and periodic care

Dentists have the responsibility to keep the proper functionality and retention of the attachments assuring the safety of the patient by constant maintenance. In order to maintain the high quality standard offered by the . LT/BT PLASTIC SOCKET, Ti-CAP, ANALOG, IMPRESSION COPPING, BLOCK OUT SPACER we recommend the substitution of the retentive elastic components yearly.

Guidelines for the patients

Patients are recommended to follow the indications provided by the dentist, to attend periodical controls and perform daily accurate hygiene.

Safety and compatibility has not been evaluated about Ti-Cap in MR environments. Heating, migration, or image artifacts have not been tested in the MR environment. Safety has not known in MR environment.

Checking up the patient with this device may result in injury to the patient.

Disposal

Follow the local laws for the disposal of the medical devices. It is suggested to wash and sterilize the products before disposal.

Instructions for use

Technical specs

Allow to manage the degree of retention of the prosthesis. Available in various retentive forces distinguishable by different colors.

LT Plastic Socket Pin type

Violet cap	1800gr./17.65N
Clear cap	1500gr./14.71N
Pink cap	900gr./8.83N
Yellow cap	700gr./6.86N
Black cap	No retention(only for laboratory use)

LT Plastic Socket No-Pin type

Violet cap	1500gr./14.71N
Clear cap	1000gr./9.8N
Pink cap	800gr./7.84N
Yellow cap	600gr./5.88N
Black cap	No retention(only for laboratory use)

BT Plastic Socket(Ø2.2 Ball type)

Clear cap	Normal size:1300gr.
Pink cap	Normal size:900gr.
Yellow cap	Normal size:500gr.
Green cap	Normal size:350gr.

ANALOG:

stainless steel device to reproduce the position and the shape of the attachment into the laboratory master model.

BLOCK OUT SPACERS:

DISPOSABLE plastic devices. used to protect the gum and to eliminate the undercuts during the fixation, with self-curing resin, of the metallic Ti-Cap + Plastic socket in the patient's mouth. Ti-Cap

prefabricated metal device designed to house the PLASTIC SOCKET; available in titanium or anodized titanium. The outer profile is designed to be cured directly in the prosthesis or to be cemented or welded into a cast reinforcement. The cementation must be done with anaerobic self-curing composite cement for metal to metal bonding.

Instructions for use

The LT/BT PLASTIC SOCKET has to be inserted inside a prefabricated Ti-CAP embodied the resin denture.

To insert or remove the PLASTIC SOCKET inside their Ti-CAP without any damage, use the appropriate PLASTIC SOCKET TOOL. Before fixing the Ti-CAP inside the denture resin, put the BLOCK OUT SPACER around the neck of the attachment, connect the Ti-CAP with the PLASTIC SOCKET on it and create enough room inside the denture; in correspondence of the Ti-CAP and check if there is enough space for the Ti-CAP; once done, fix it with self curing resin.

To avoid the loss of the performances of the PLASTIC SOCKET replace them every 12 months.

Any use of the "PLASTIC SOCKET" which does not follow the present instructions is considered improper.

ANALOG

place the correct ANALOG into the corresponding IMPRESSION COPING, make sure the two elements are correctly coupled and proceed with the production of the master model according to the technique chosen in the laboratory.

Ti-Cap

prefabricated devices that can be welded or cemented into cast reinforcements or cured directly in the denture resin.

- SEWON MEDIX products are sterile medical devices.



SewonMedix Inc.
#29, Sasang-ro 375beon-gil, Sasang-Gu, Busan,
Republic of Korea (46946)
www.sewonmedix.com
Tel : +82 51 303 1713 Fax : +82 51 303 1714



OBELIS S.A
Bd. Général Wahis 53-1030
Brussels Belgium
Telephone: +32 2 732 59 54 Fax: +32 2 732 60 03

CE 1639



Do not reuse



CAUTION



Date of manufacture



EC Representative



Manufacture



Consult instructions for use



Batch code



Catalogue no.



Temperature limitation



Use by date



Sterilized using irradiation





Do not Re-sterilize

Rx Only

Caution : Federal Law (US) restricts this product to sale by or on the order of a dentist or physician

Material characteristics

Titanium Gr4 used for fixture and abutments

Material type 	Surgical grade cp titanium based on ASTM F67 Gr4 
Composition(in wt. %)	Nitrogen $\leq 0.005\%$ Carbon $\leq 0.05\%$ Hydrogen $\leq 0.0034\%$ Iron $\leq 0.16\%$ Oxygen $\leq 0.35\%$ Titanium = balance
Yield strenght($R_{p0.2}$)	min. 662MPa
Tensile strength(R_m)	min. 785MPa



Titanium alloy used for abutments

Material type	Surgical grade titanium alloy Ti-6Al-4V ELI according to ASTM F136
Composition(in wt. %)	Aluminum $\leq 6.1\%$ Vanadium $\leq 4.1\%$ Nitrogen $\leq 0.004\%$ Carbon $\leq 0.03\%$ Hydrogen $\leq 0.0024\%$ Iron $\leq 0.15\%$ Oxygen $\leq 0.11\%$ Titanium = balance
Yield strenght($R_{p0.2}$)	min. 1007MPa
Tensile strength(R_m)	min. 1227MPa





MEMO

MEMO

IH SYSTEM

PRODUCT CATALOG

PRODUCT CATALOG_R6.2

11th January 2022



SEWON MEDIX INC.

Head office #29, Sasang-ro 375beon-gil, Sasang-gu, Busan 46946, Republic of Korea
T+82-51-303-1713 F+82-51-303-1714

Homepage : www.sewonmedix.com

e-mail : info@sewonmedix.com